

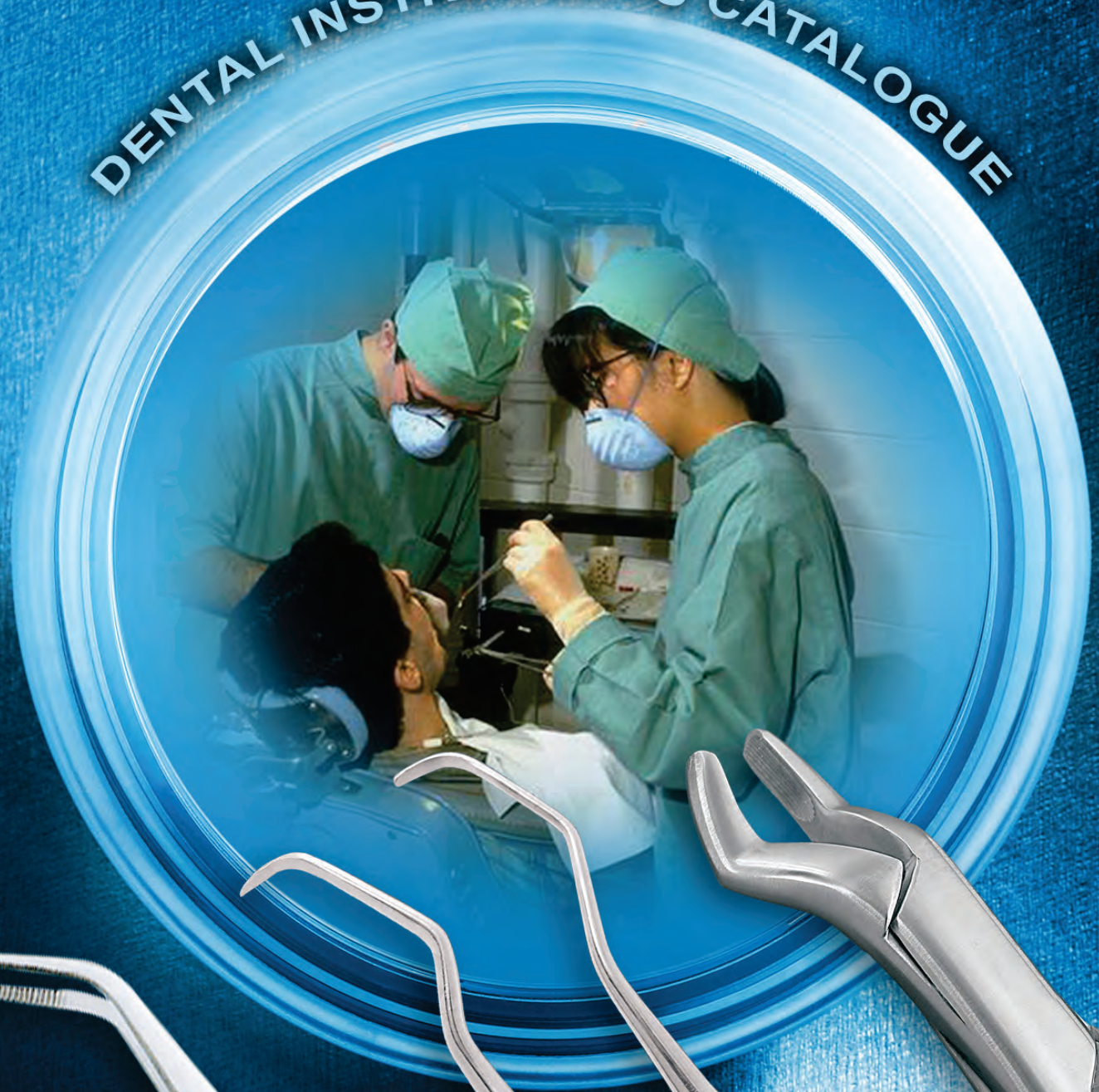

**AWARD  
INDUSTRIES**

DENTAL INSTRUMENTS CATALOGUE





**DENTAL  
INSTRUMENTS**



## **GUARANTEE**

ALL SABRI DENTAL INSTRUMENTS ARE GUARANTEED TO BE FREE FROM DEFECTS IN WORKMANSHIP AND MATERIALLY AND INSTRUMENT WHICH PROVES DEFECTIVE WHEN USED FOR ITS INTENDED SURGICAL PURPOSE WILL BE REPLACED OR REPAIR AT NO COST.

ALL INSTRUMENTS  
SHOWN IN THIS CATALOG  
ARE MADE OF STAINLESS  
STEEL, UNLESS  
OTHERWISE MENTIONED



Serial No.	Description	Page No.	Serial No.	Description	Page No.
1	Extracting Forceps (DNF #) .....	5-19	20	Gauges & Dividers .....	59
2	Elevators (DNL #) .....	20-23	21	Hand Instruments (Explorers, Probes Excavators, Curettes, Scalers, Periodontal, Plastic Filling Instruments) .....	60-75
3	Rongeurs .....	24-27	22	Amalgam Instruments .....	76-77
4	Bone Curettes, Files And Chisels .....	28-31	23	Crown Instruments .....	78
5	Bone Mallets, Forceps .....	32-33	24	Matrix Retainers & Bands .....	79
6	Lip & Cheek Retractors .....	34	25	Wax, Porcelain And Cement Instruments .....	80-85
7	Tongue Seizing Forceps, Depressors .....	35	26	Misc. Lab Instruments .....	86
8	Mouth Gags .....	36	27	Pliers .....	87-90
9	Gum Scissors .....	37-41	28	Orthodontic Items .....	91
10	Surgical Scissors .....	42-43	29	Endo Instruments .....	92-93
11	C&c Scissors .....	44	30	Articulating Paper Forceps .....	94
12	Tissue & Dressing Forceps .....	45-46	31	Rubber Dam Instruments .....	95
13	Tissue Retractors .....	47	32	Scalpels .....	96-97
14	Towel Claps, Napkin Holders .....	48	33	Probes & Suction Tubes .....	98
15	Hemostatic Forceps .....	49	34	Alphabetical Index .....	99-101
16	Needle Holders .....	50-54			
17	Impression Trays .....	55-56			
18	Cotton & Dressing Pliers .....	57			
19	Mouth Mirrors .....	58			



# EXTRACTING FORCEPS



## UPPER MOLARS

**“Sure-Grip”  
Serrated  
Beaks**

**All extracting  
forceps also available  
with serrated beaks.**

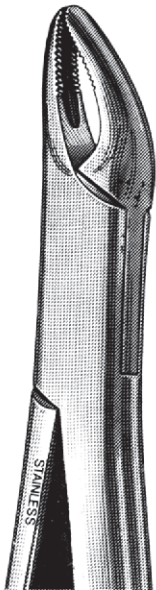

**To obtain sure-grip  
serrated beaks specify  
“SB” after forceps  
model number.**

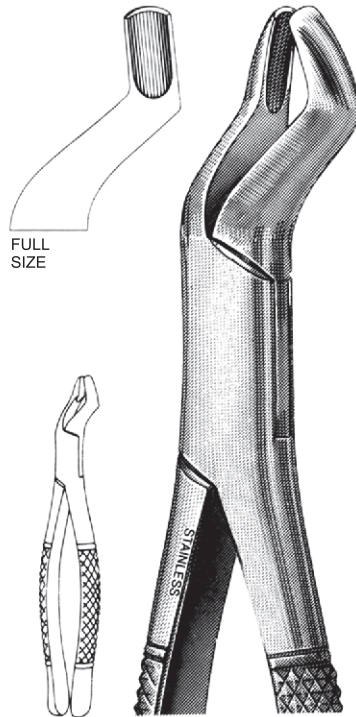

**DNF 10S**  
Upper Molars;  
Universal

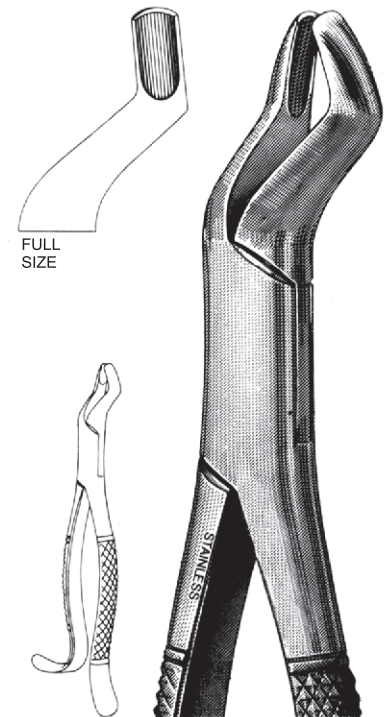

**DNF 10H**  
Upper Molars, Hook  
Handle; Universal

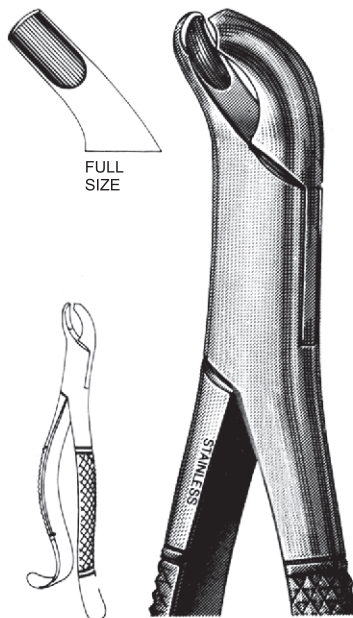

**DNF 18L**  
1st & 2nd Upper  
Molar; Left

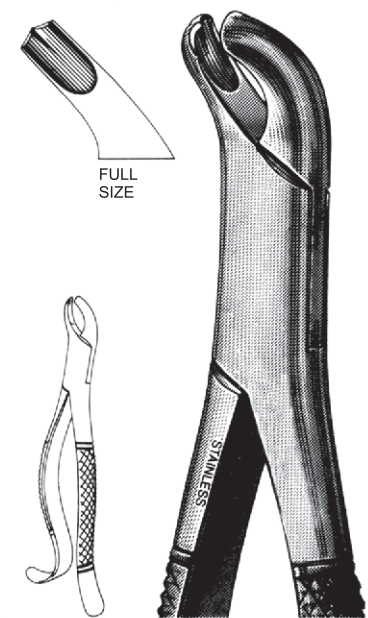

**DNF 18R**  
1st & 2nd Upper  
Molar; Right

To obtain sure-grip serrated beaks specify 'SB' after forceps model number.



# EXTRACTING FORCEPS



## UPPER MOLARS

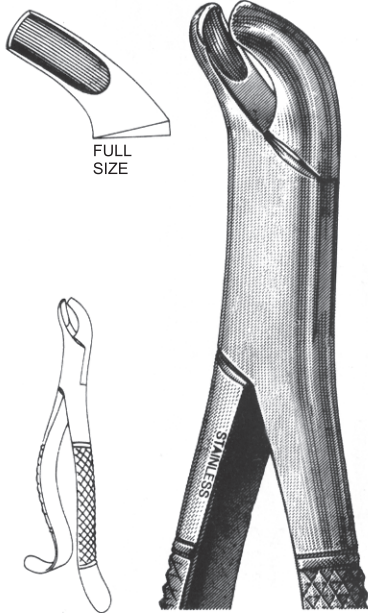

**DNF 24**  
Upper Molars; Universal

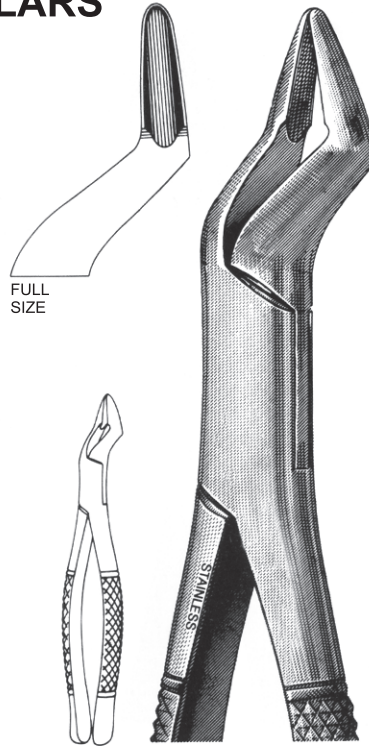

**DNF 32**  
Upper Cuspids, Bicuspids  
and Molars; Universal

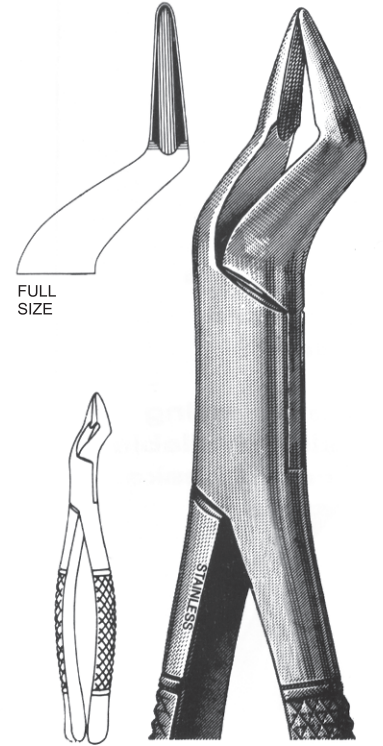

**DNF 32A**  
Upper Cuspids, Bicuspids,  
Molars and Roots; Universal

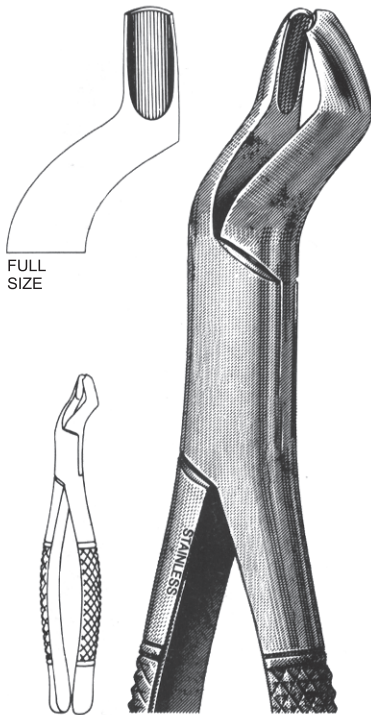

**DNF 53L**  
1 st and 2nd Upper Molars; Left

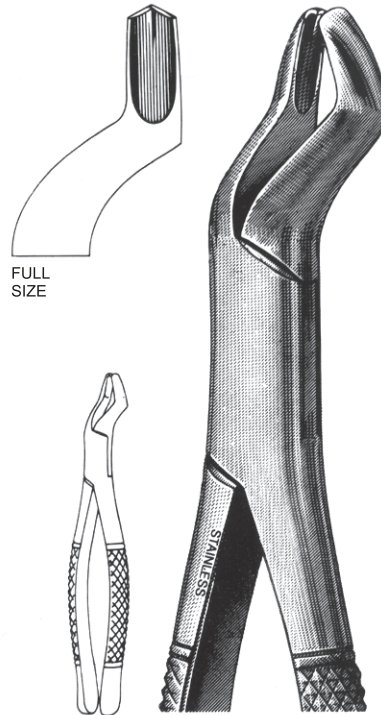

**DNF 53R**  
1 st and 2nd Upper Molars; Right

To obtain sure-grip serrated beaks specify 'SB' after forceps model number.



# EXTRACTING FORCEPS

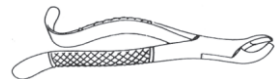

## UPPER MOLARS

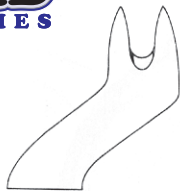

FULL  
SIZE

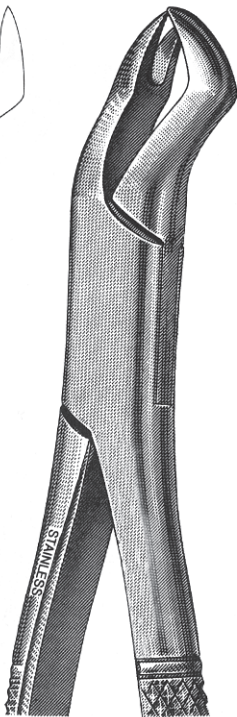

**DNF 88L**

1 st and 2nd Upper Molars; Left



FULL  
SIZE

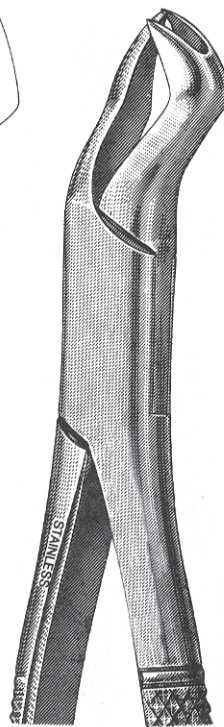

**DNF 88R**

1 st and 2nd Upper Molars; Right

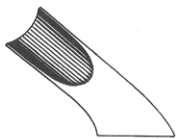

FULL  
SIZE

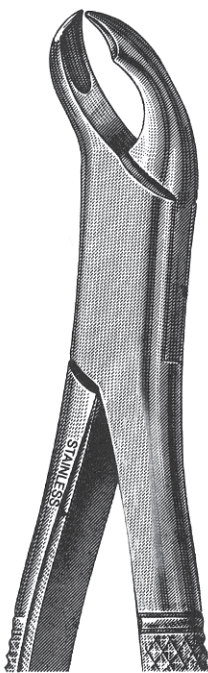

**DNF 90**

Upper Molars; Left

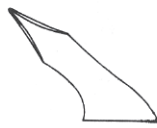

FULL  
SIZE

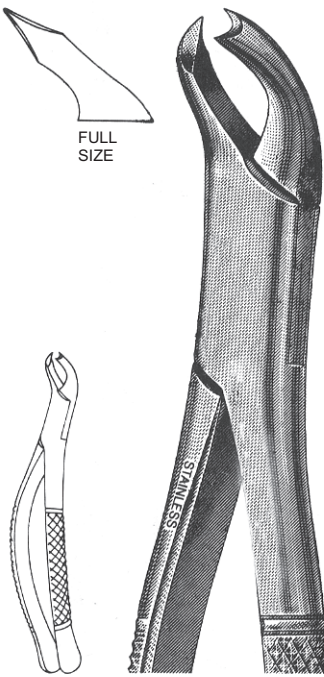

**DNF 89**

Upper Molars; Right

To obtain sure-grip serrated beaks specify 'SB' after forceps model number.



# EXTRACTING FORCEPS



## UPPER MOLARS

## LOWER MOLARS

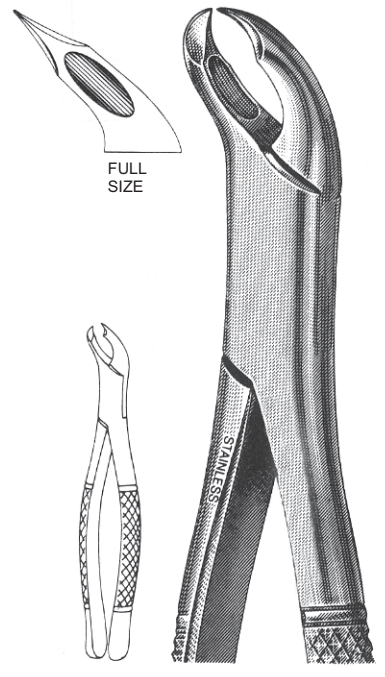
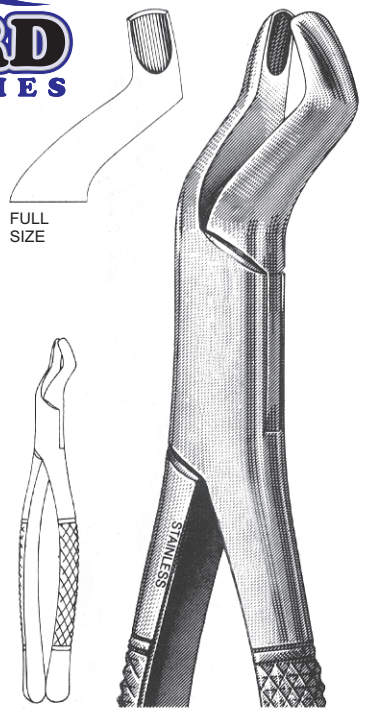

**DNF 210S**  
3rd Upper Molars; Universal

**DNF 3FS**  
Lower Molars; Woodward

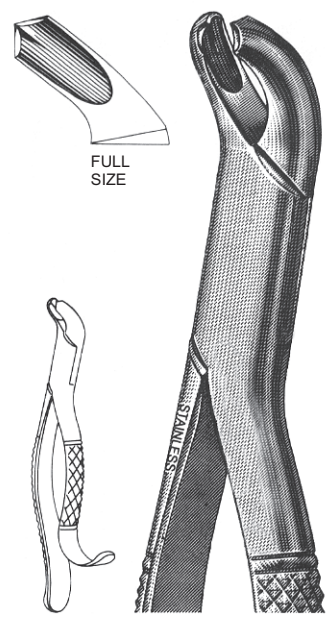
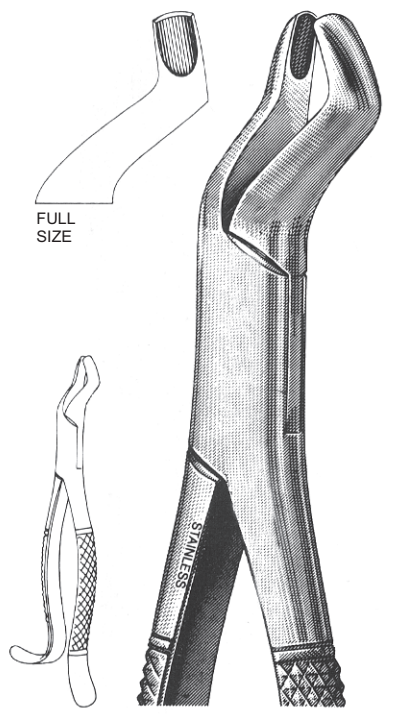

**DNF 210H**  
3rd Upper Molars; Universal, Hook Handle

**DNF 15**  
1st & 2nd Lower Molars; Universal

To obtain sure-grip serrated beaks specify 'SB' after forceps model number.





# EXTRACTING FORCEPS



## LOWER MOLARS

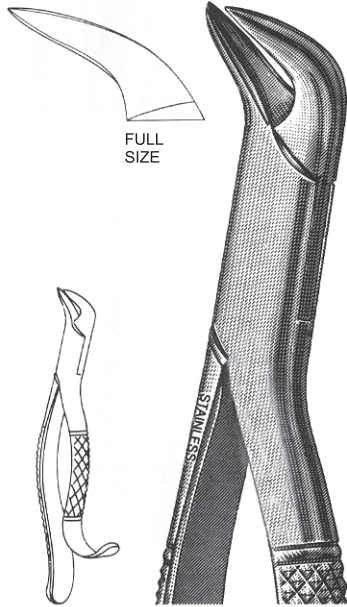

**DNF 16**

1 st & 2nd Lower Molars;  
Universal; Cow Horn

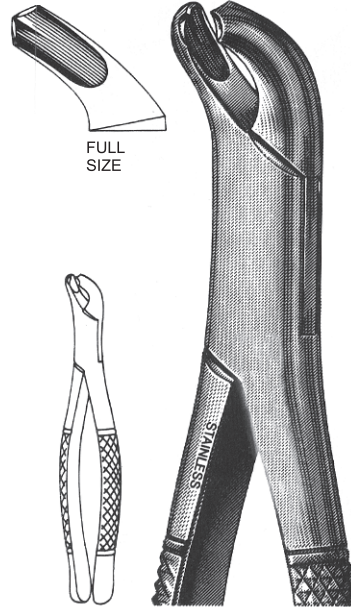

**DNF 17**

1 st & 2nd Lower Molars; Universal

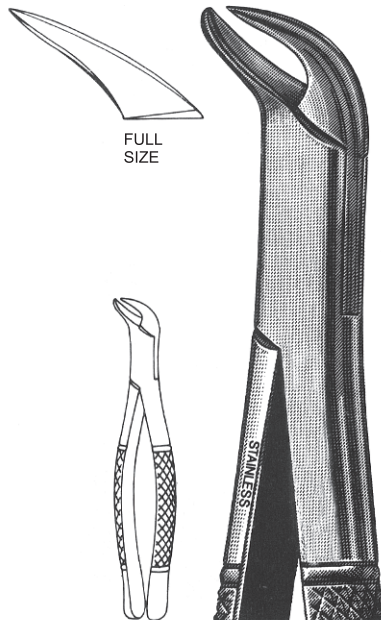

**DNF 23**

1 st & 2nd Lower Molars;  
Universal; Cow Horn

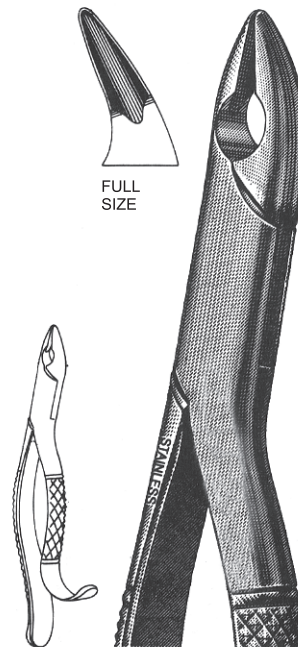

**DNF-85A**

Lower Molars, Cuspids  
and Bicuspid; Universal

To obtain sure-grip serrated beaks specify 'SB' after forceps model number.



# EXTRACTING FORCEPS



## LOWER MOLARS

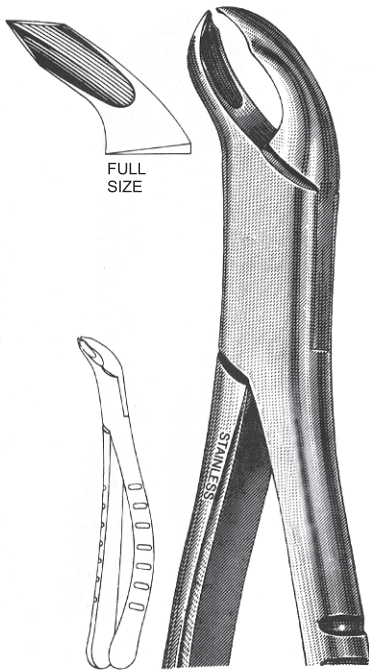

FULL SIZE

**DNF 217**

1 st & 2nd Lower Molars; Universal

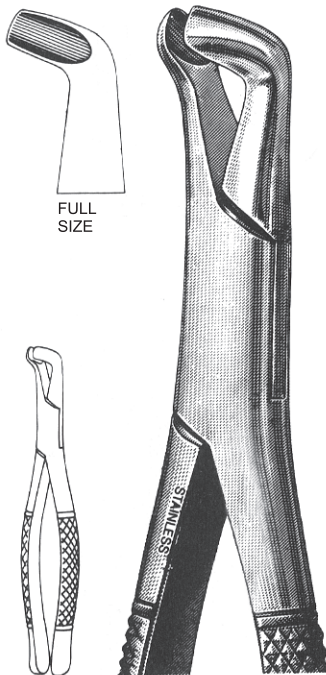

FULL SIZE

**DNF 222**

3rd Lower Molar; Universal

## UPPER MOLARS

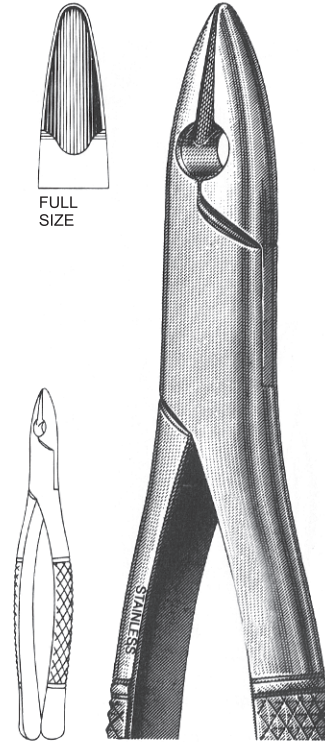

FULL SIZE

**DNF 1STD**

Upper Incisors and cuspids

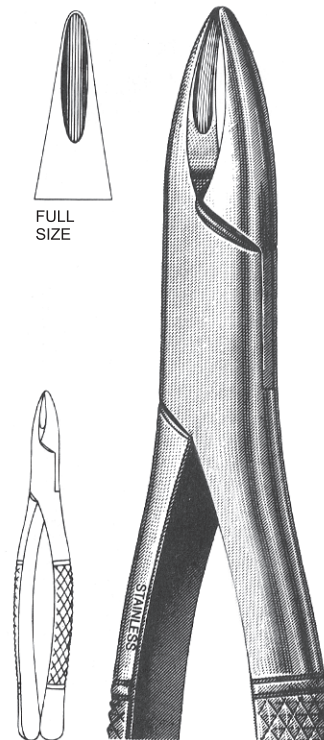

FULL SIZE

**DNF 1HEN**

Upper Incisors; Henahan

To obtain sure-grip serrated beaks specify 'SB' after forceps model number.

# EXTRACTING FORCEPS



## UPPER ANTERIORS

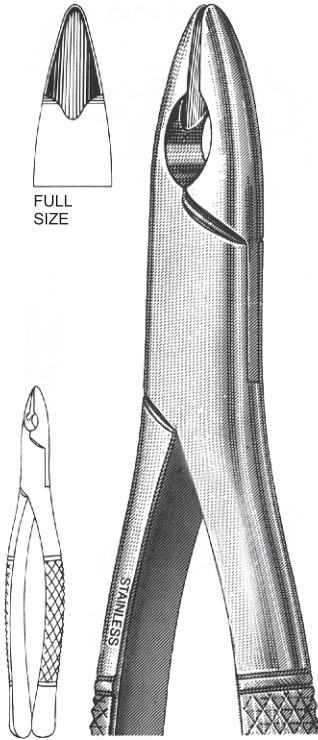

FULL  
SIZE

**DNF 99C**  
Upper Incisors, Cuspids  
and Bicuspids

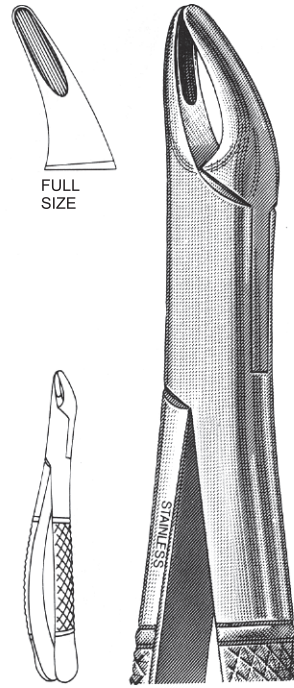

FULL  
SIZE

**DNF 150**  
Upper Incisors, Cuspids,  
Bicuspids and Roots; Universal

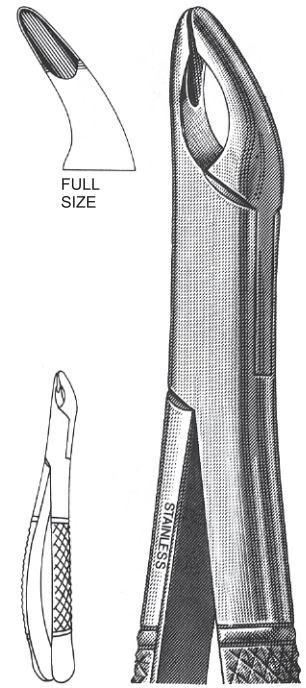

FULL  
SIZE

**DNF 150A**  
Upper Incisors, Cuspids,  
and Bicuspids; Universal;  
Parallel Beaks

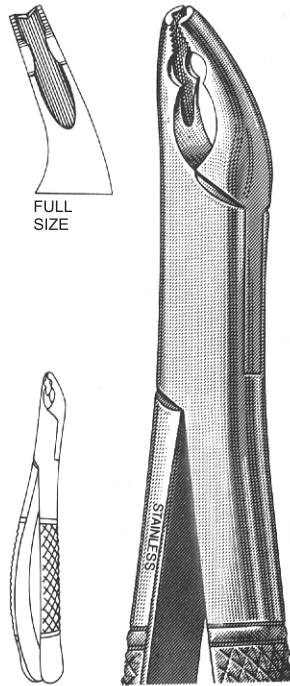

FULL  
SIZE

**DNF 150AS**  
Upper Anteriors; Split Beaks; Serrated

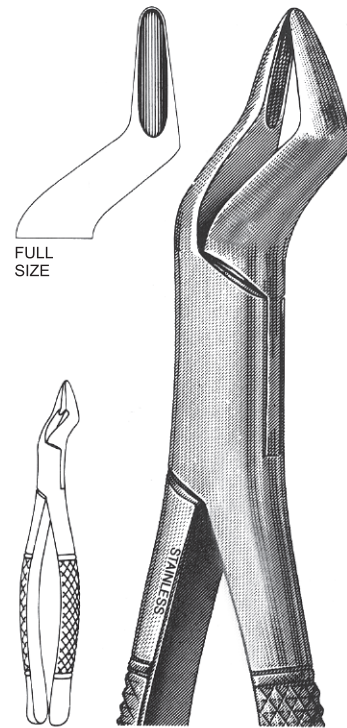

FULL  
SIZE

**DNF 286**  
Upper Bicuspids, Incisors and Roots

To obtain sure-grip serrated beaks specify 'SB' after forceps model number.



# EXTRACTING FORCEPS



## LOWER ANTERIORS

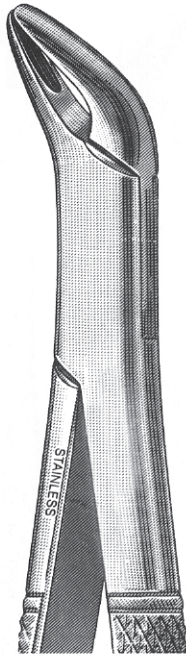
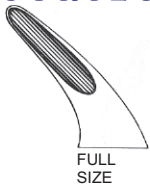

**DNF 151**  
Lower Incisors, Cuspids,  
Bicuspids and Roots, Universal

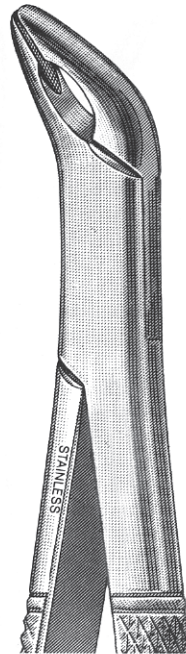
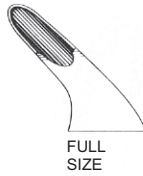

**DNF 151A**  
Lower Incisors,  
Cuspids, Bicuspids  
universal; parallel beaks

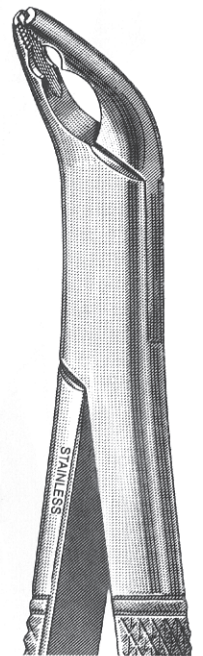
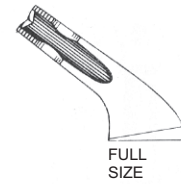

**DNF 151AS**  
Lower Anteriors;  
Split Beaks; Serrated

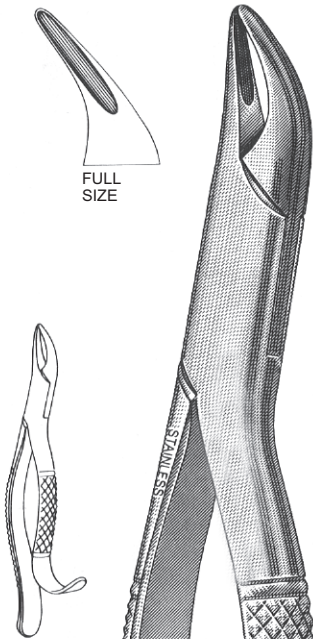
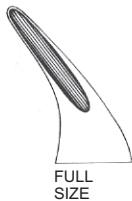

**DNF 103**  
Lower Bicuspids,  
Incisors and Roots; Universal

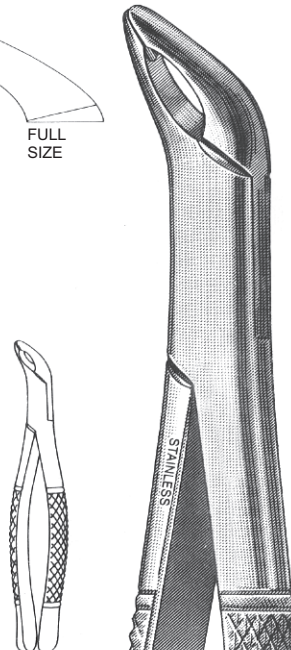
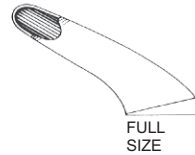

**DNF 203**  
Lower Bicuspids, Cuspids,  
Incisors and Roots, Universal

To obtain sure-grip serrated beaks specify 'SB' after forceps model number.



# EXTRACTING FORCEPS

## UPPER AND LOWER ANTERIORS AND SPLITTING



## ROOTS

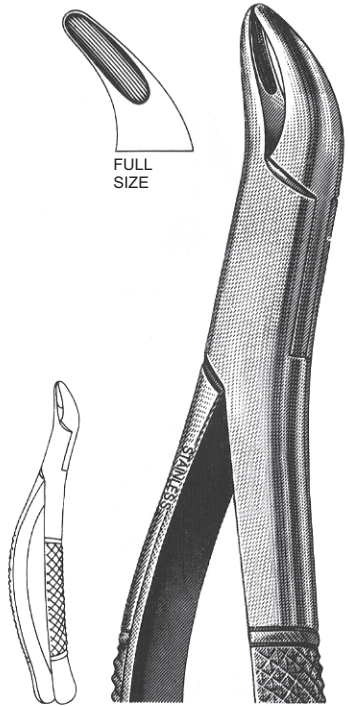

FULL SIZE

**DNF 62**

Upper and Lower incisors, Cuspids, Bicuspid and Deciduous; Universal

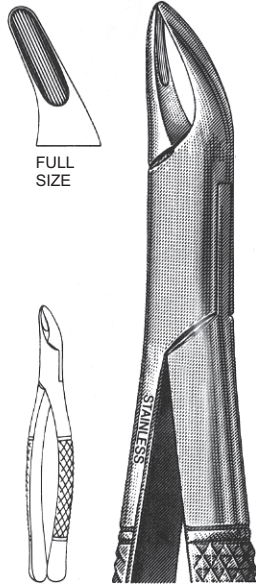

FULL SIZE

**DNF 101**

Upper and Lower Bicuspid and Deciduous; Universal

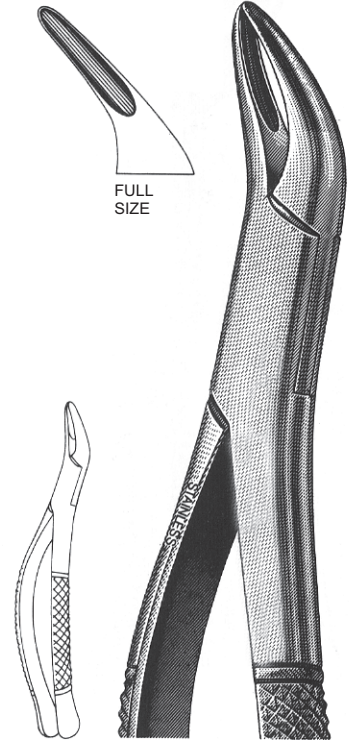

FULL SIZE

**DNF 69**

Upper and Lower Fragments and Roots

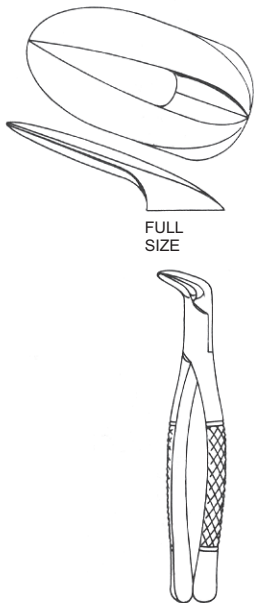

FULL SIZE

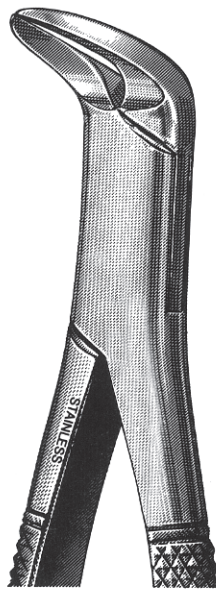

**DNF 6**

Upper and Lower Splitting and Separating

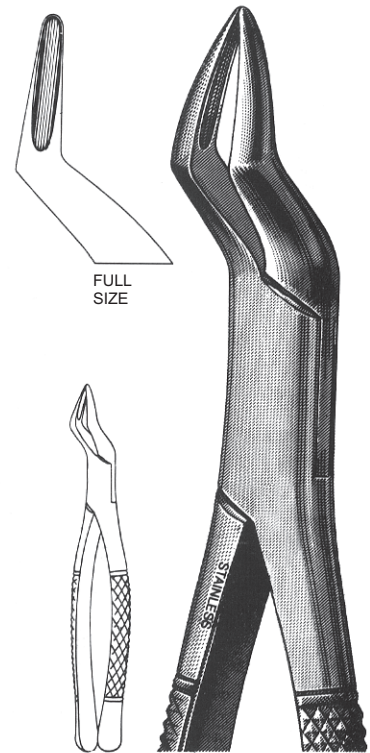

FULL SIZE

**DNF 65**

Upper Incisors, Roots and Fragments

To obtain sure-grip serrated beaks specify 'SB' after forceps model number.

# EXTRACTING FORCEPS



## ROOTS

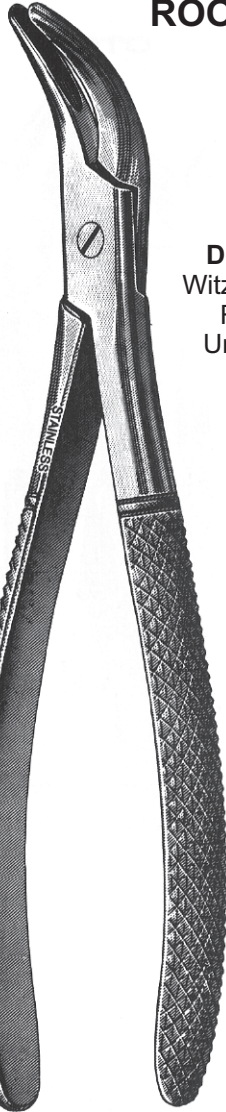
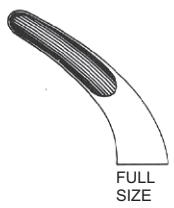

**DNF 116**  
Witzel Lower  
Roots;  
Universal



**DNF 120**  
Witzel Upper Roots;  
Universal

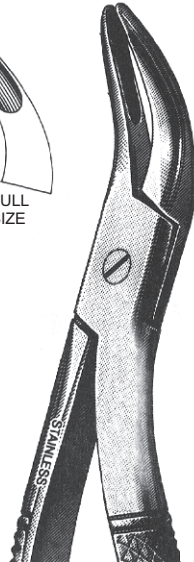

## SPLINTER

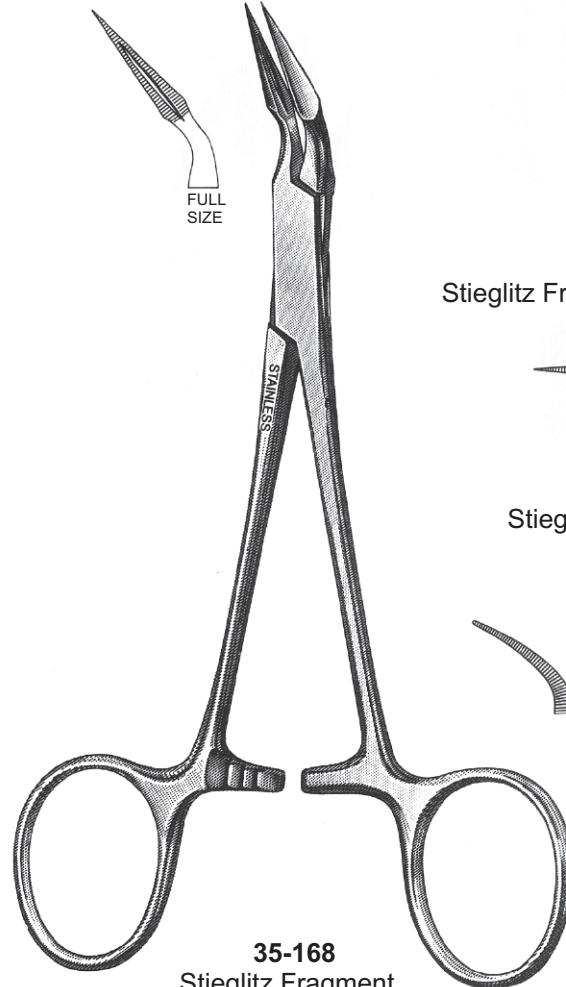
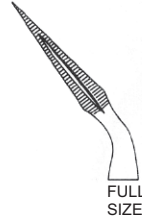

**35-168**  
Stieglitz Fragment,  
5 1/4" , 45°



**35-169**  
Stieglitz Fragment, 5 1/2" Straight

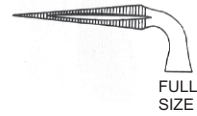

**35-170**  
Stieglitz Fragment, 4 3/4" , 90°

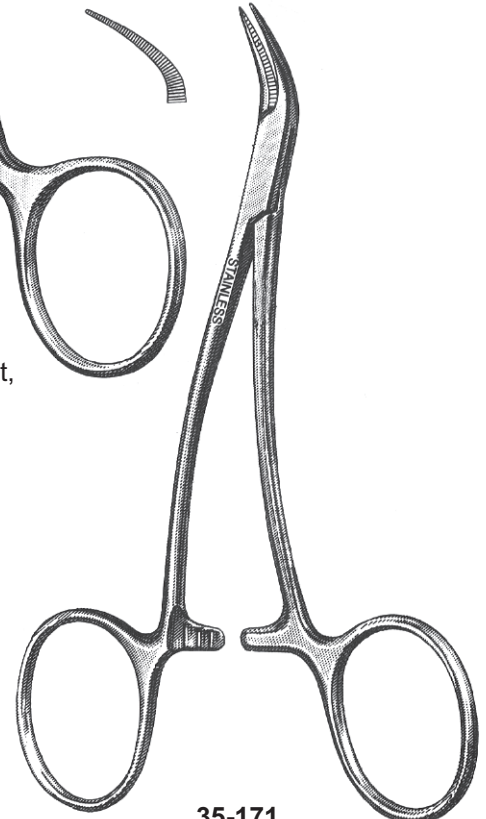

**35-171**  
Peets Splinter, 4 3/4" , 45°

To obtain sure-grip serrated beaks specify 'SB' after forceps model number.

# EXTRACTING FORCEPS



## MEAD PATTERN

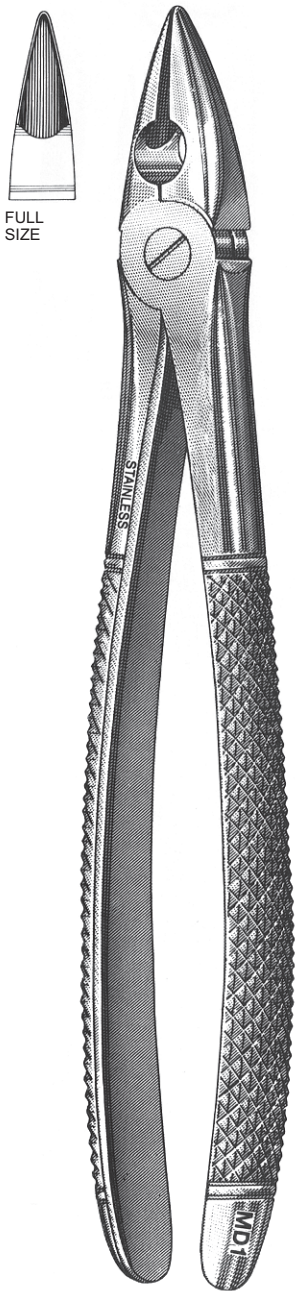

**DNF MD1**  
Upper Incisors, Cuspids, Bicuspid  
and Roots: Mead; Universal.

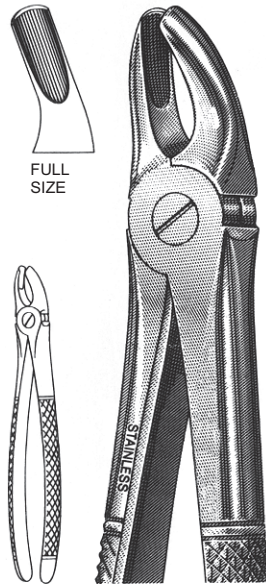

**DNF MD2**  
Upper 1st, 2nd and 3rd  
Molars; Mead; Universal

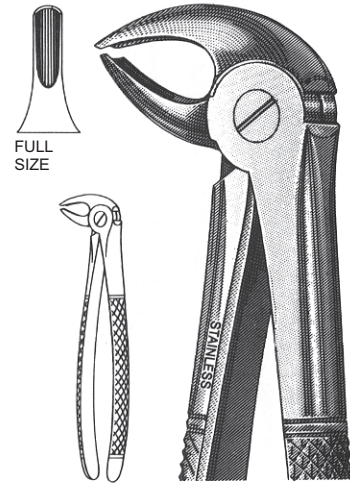

**DNF MD3**  
Lower Incisors, Cuspids, Bicuspid  
and Roots; Mead; Universal

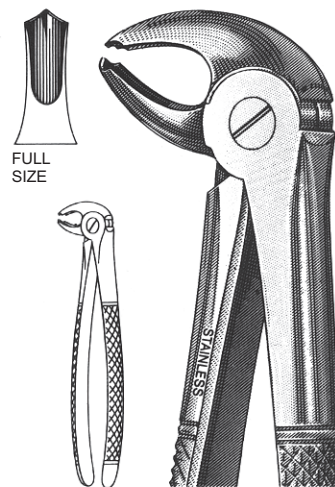

**DNF MD4**  
Lower 1st, 2nd and 3rd  
Molars; Mead; Universal

To obtain sure-grip serrated beaks specify 'SB' after forceps model number.

# EXTRACTING FORCEPS

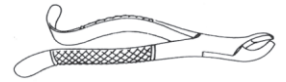

## ENGLISH PATTERN



FULL SIZE

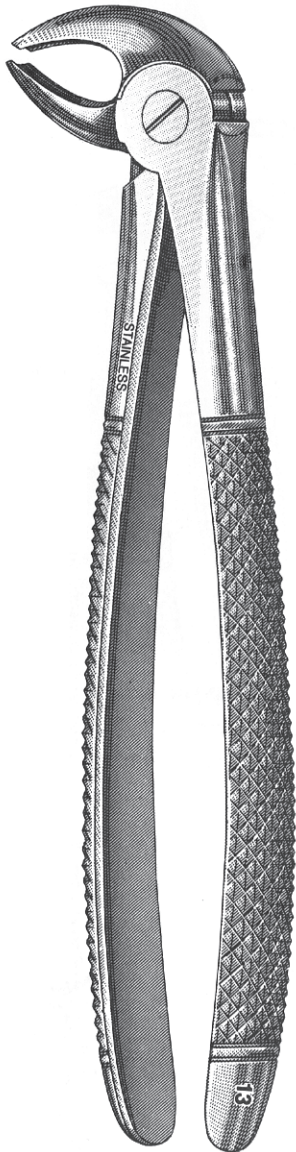

**DNF 13**  
Lower Bicuspids; Universal



FULL SIZE

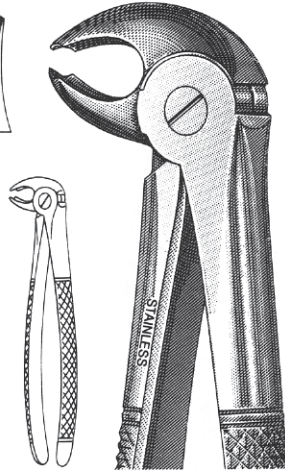

**DNF 22**  
Lower Molars; Universal



FULL SIZE

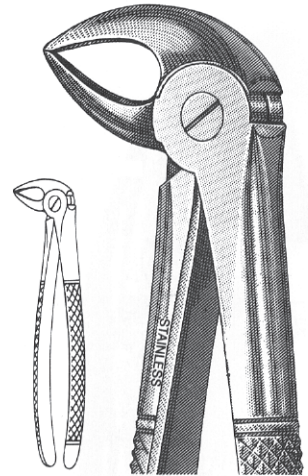

**DNF 33**  
Lower Roots



FULL SIZE

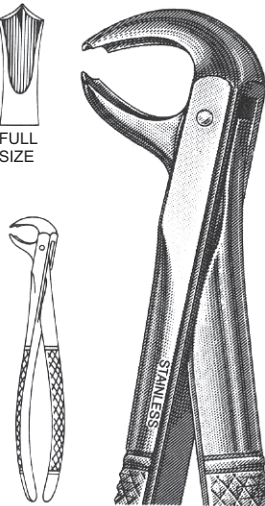

**DNF 73**  
Lower Molars; Universal

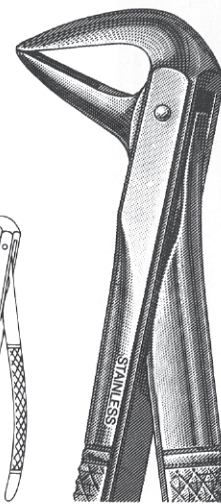

**DNF 74**  
Lower Roots



FULL SIZE

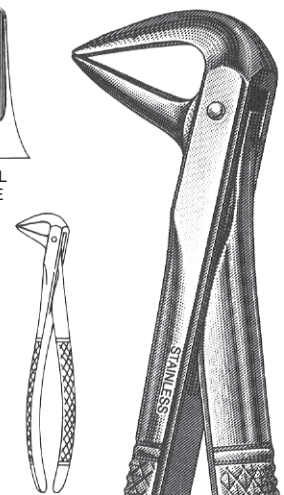

**DNF 74N**  
Lower Roots; Narrow Beaks

To obtain sure-grip serrated beaks specify 'SB' after forceps model number.





# EXTRACTING FORCEPS



## PEDODONTIC

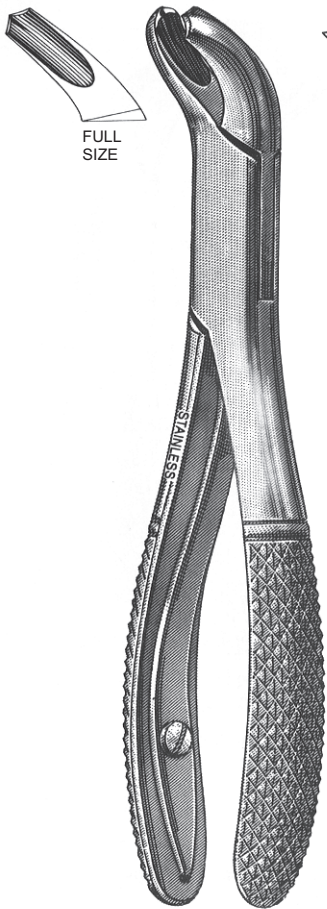

**DNF 17S**  
 Pedo Lower Molars;  
 Universal; Spring Handle;  
 4 3/4 "

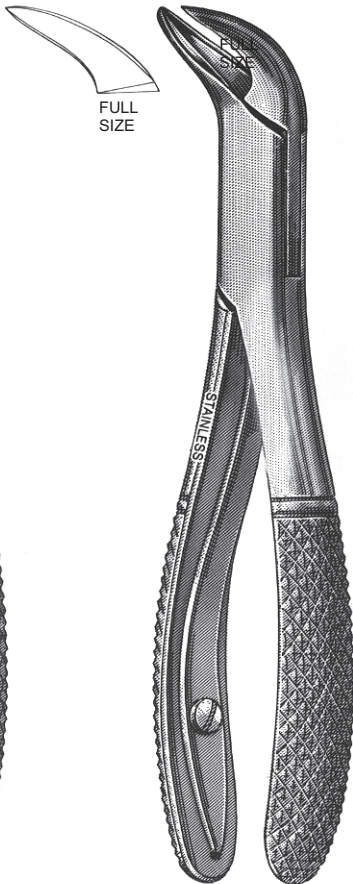

**DNF 23S**  
 Pedo Lower Molars  
 Universal; Cow Horn;  
 spring Handle; 4 3/4 "

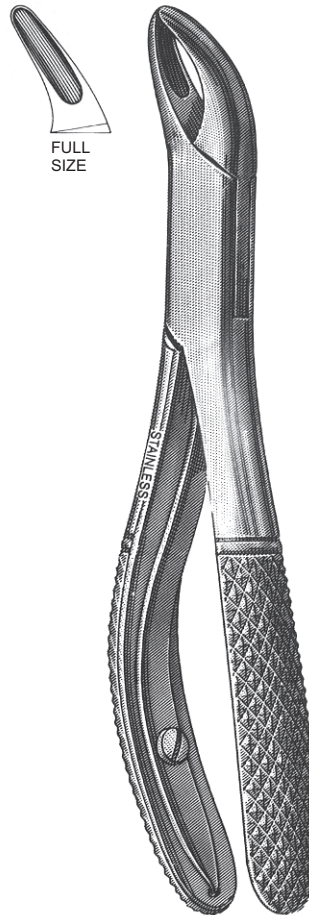

**DNF 150 1/2S**  
 Pedo Upper Incisors, Bicuspid  
 and Roots; Universal;  
 Spring Handle; 4 3/4 "

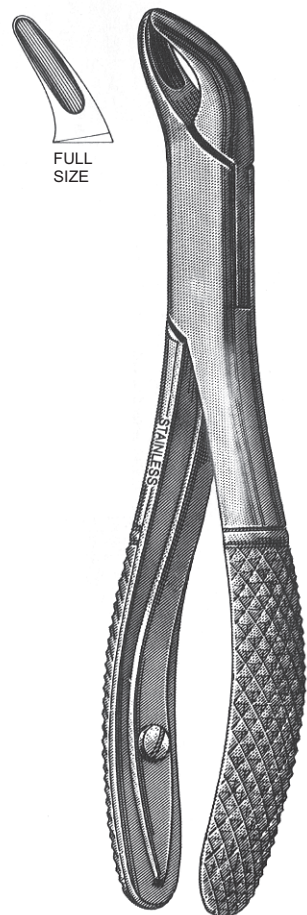

**DNF 151 1/2S**  
 Pedo Lower Incisors,  
 Bicuspid and Roots;  
 Universal; Spring Handle;  
 4 3/4 "

To obtain sure-grip serrated beaks specify 'SB' after forceps model number.



# EXTRACTING FORCEPS

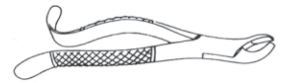

## PEDODONTIC



FULL SIZE

**DNF 16S**  
Pedo Lower Molars; Cow Horn

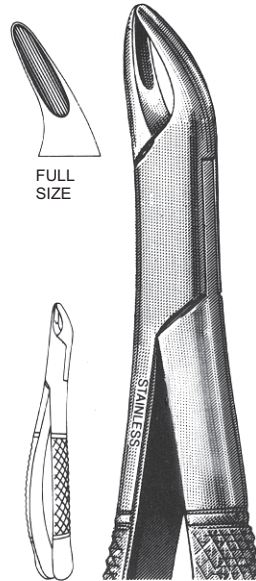

FULL SIZE

**DNF 150S**  
Pedo Upper Incisors,  
Bicuspids and Roots;  
Universal

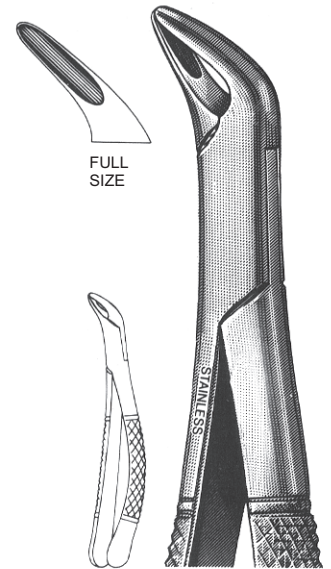

FULL SIZE

**DNF 151S**  
Pedo Lower Incisors,  
Bicuspids and Roots;  
Universal

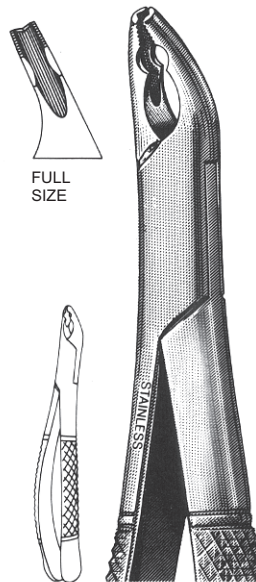

FULL SIZE

**DNF 150XAS**  
Pedo Upper Anteriors;  
Split Beaks, Serrated

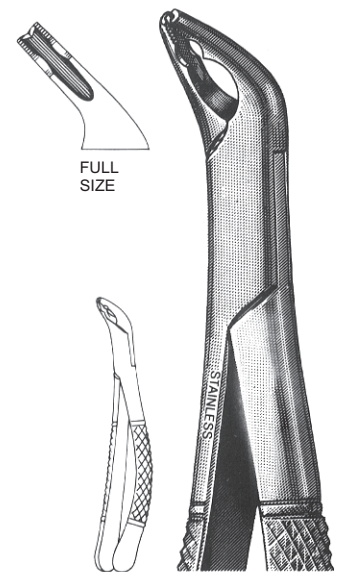

FULL SIZE

**DNF 151XAS**  
Pedo Lower Anteriors;  
Split Beaks, Serrated

To obtain sure-grip serrated beaks specify 'SB' after forceps model number.

# EXTRACTING FORCEPS



## PEDODONTIC-ENGLISH PATTERN

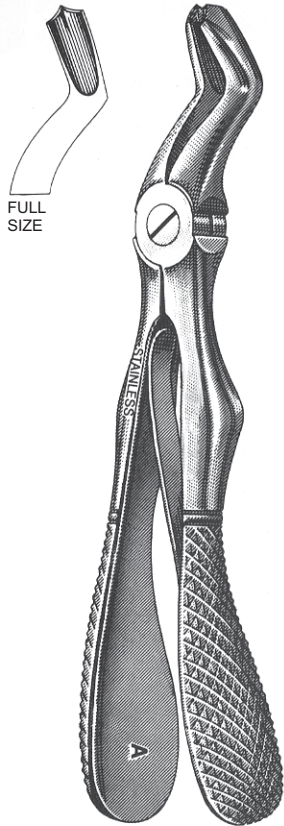

**DNF A**  
Pedo Upper Molar;  
Universal; Mini

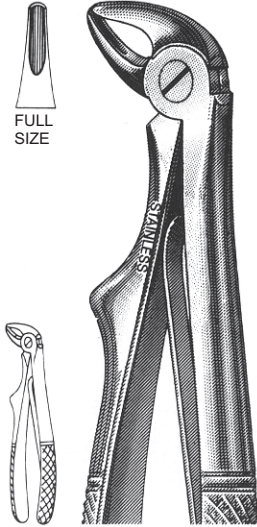

**DNF B**  
Pedo Lower Root;  
Universal; Mini

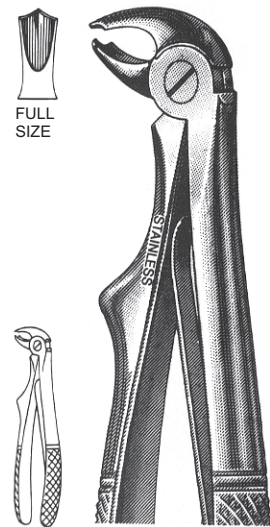

**DNF C**  
Pedo Lower Molars; Universal; Mini

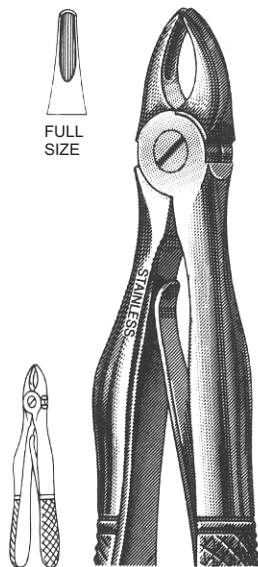

**DNF E**  
Pedo Upper Front; Mini

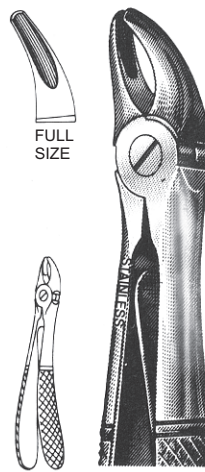

**DNF F**  
Pedo Upper Root;  
Universal; Mini

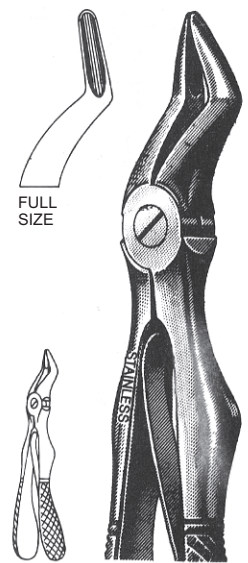

**DNF H**  
Pedo Upper and Lower;  
Universal; Mini

To obtain sure-grip serrated beaks specify 'SB' after forceps model number.



# ELEVATORS



## APICAL

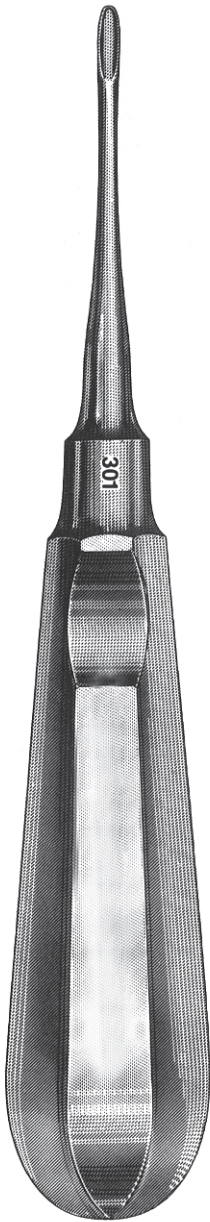

DNL 301



DNL 302



DNL 303

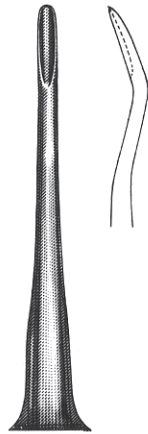

DNL 302 HF



DNL 303 HF

## SELDIN



DNL 1L



DNL 1R



DNL 4L



DNL 4R



# ELEVATORS

## CRANE PICK

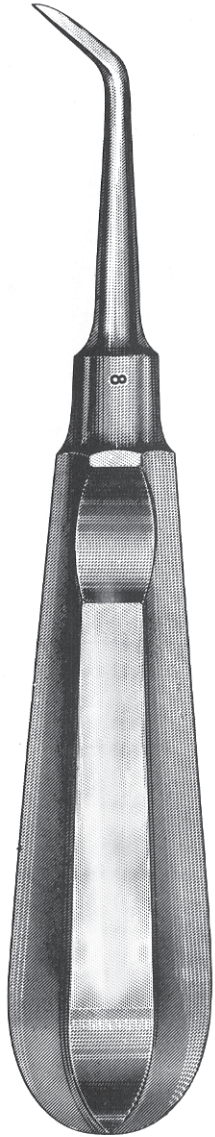

DNL 8

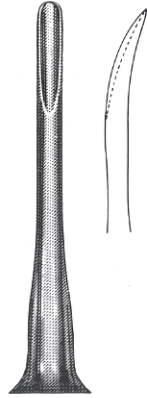

DNL 3



DNL 81



DNLA

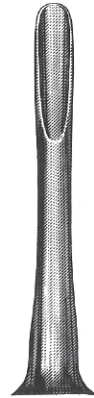

DNL 34



DNL 34S



DNL 46



## CRYER



DNL 44



DNL 45



DNL 25



DNL 26



# ELEVATORS

## ROOT TIP

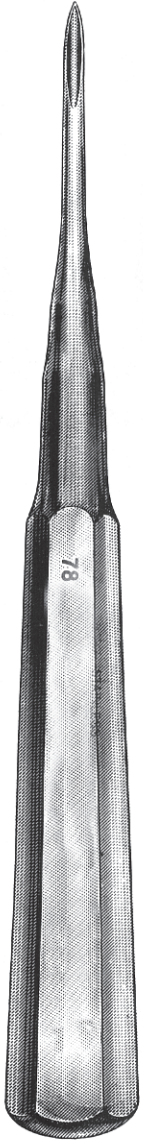

DNL 78

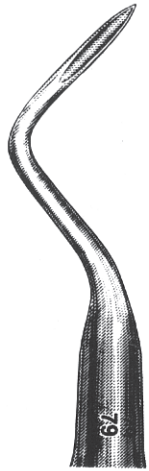

DNL 79

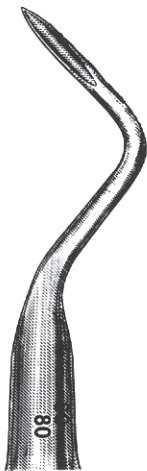

DNL 80

## HEIDBRINK ROOT-TIP PICKS



DNL H1



DNL H2



DNL H3

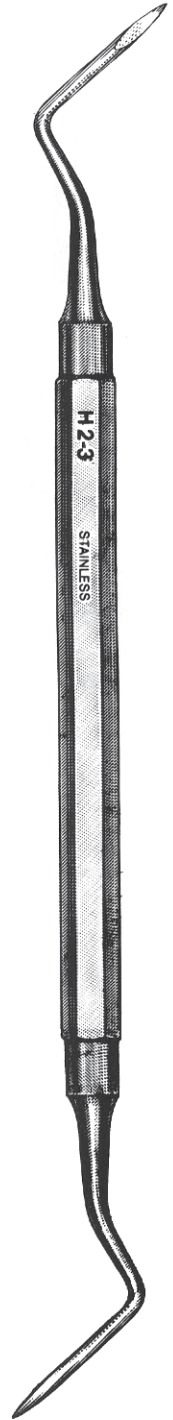

DNL H2-3



# ELEVATORS

## POTTS

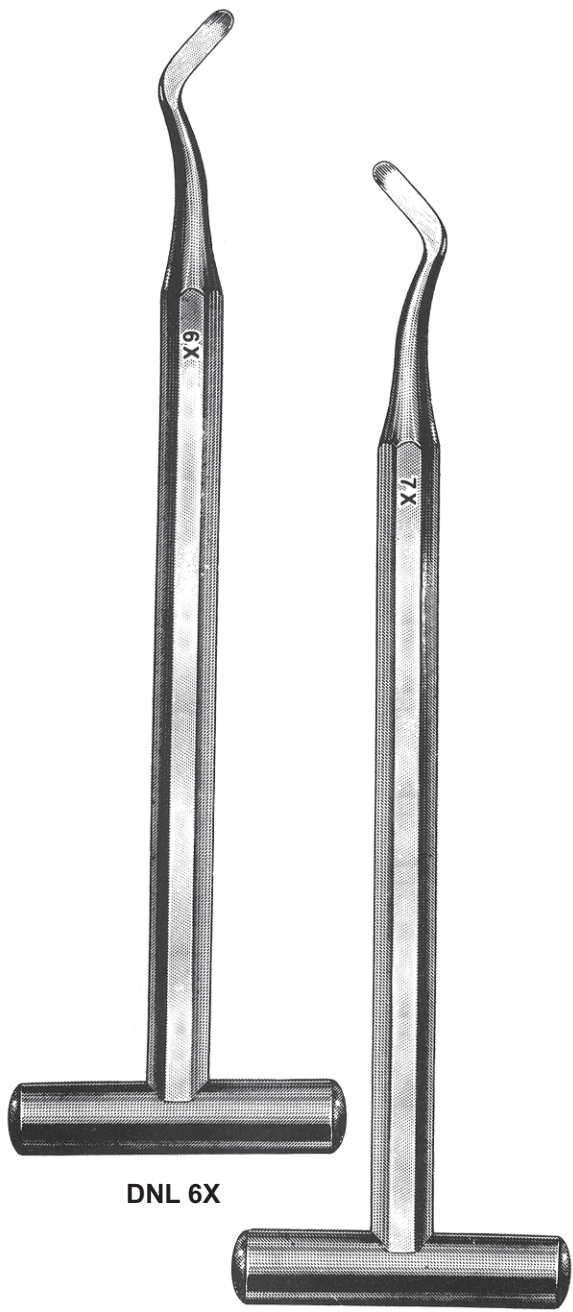

DNL 6X

DNL 7X

## PERIOSTEAL

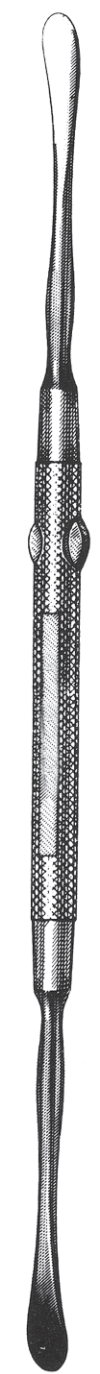

DNL FREER



DNL W2,  
WEST

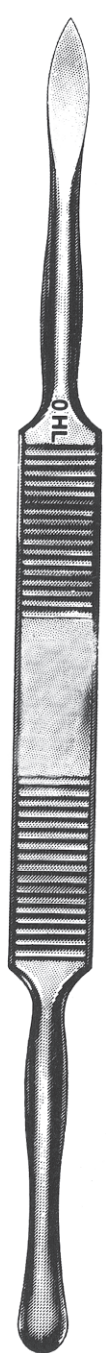

DNL OHL

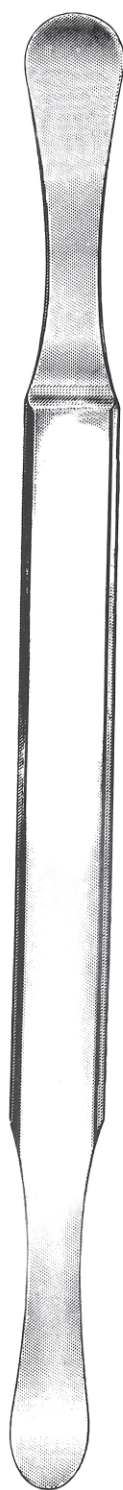

DNL S23,  
SELDIN

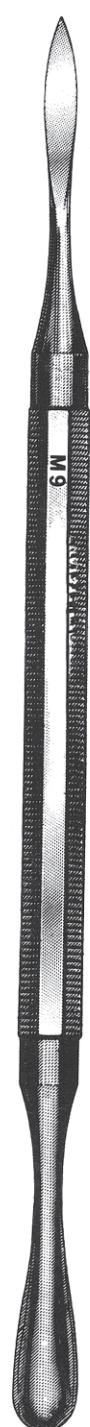

DNL M9,  
MOLT



# Rongeurs

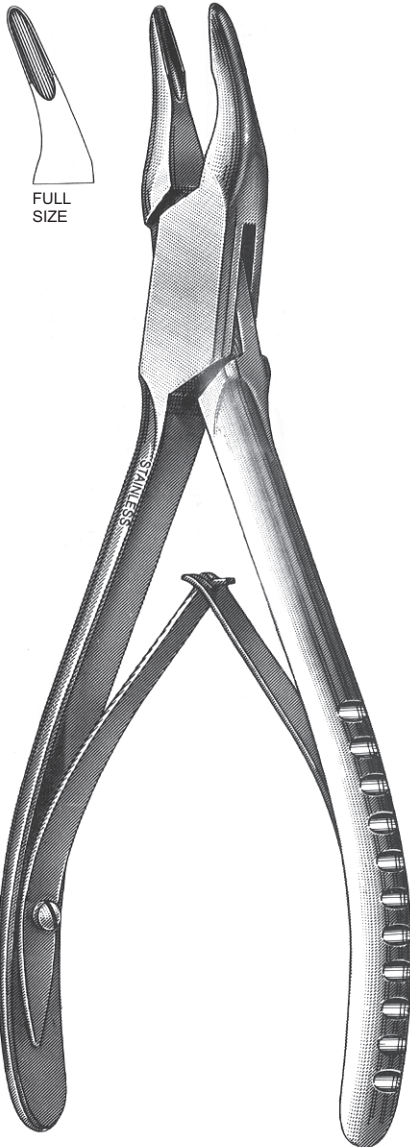
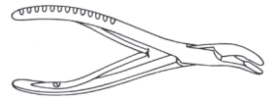

**36-172**  
BLUMENTHAL 6"  
30° Standard

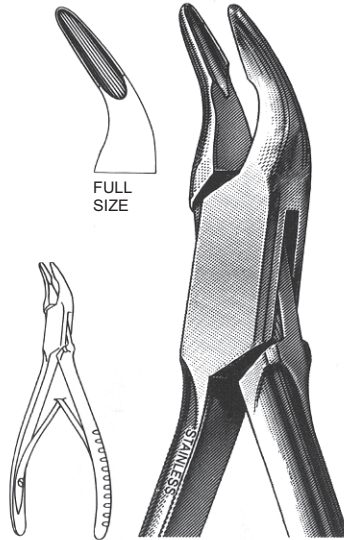

**36-173**  
BLUMENTHAL 6" 45°

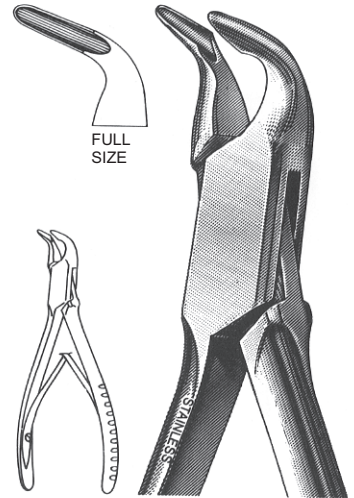

**36-174**  
BLUMENTHAL 6" 90°

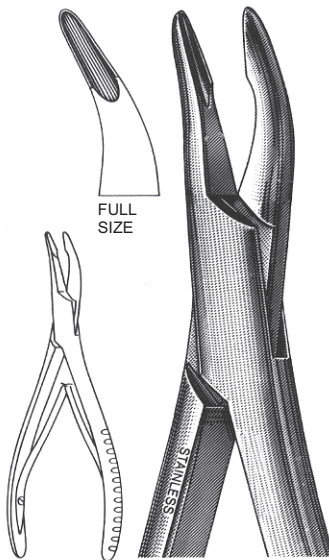

**36-175**  
BLUMENTHAL 7" 30°

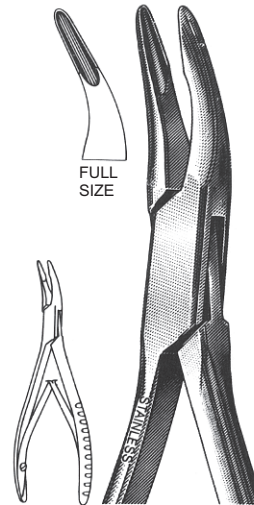

**35-176**  
MINI-BLUMENTHAL  
4 1/2" 30°

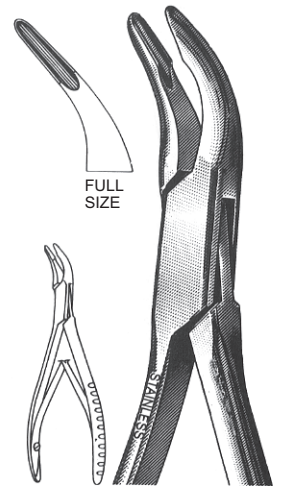

**35-177**  
MINI\_BLUMENTHAL  
4 1/2" 45°





# Rongeurs

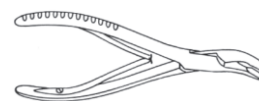

**36-178**  
No. 5-Side Cutting, 6 3/4"

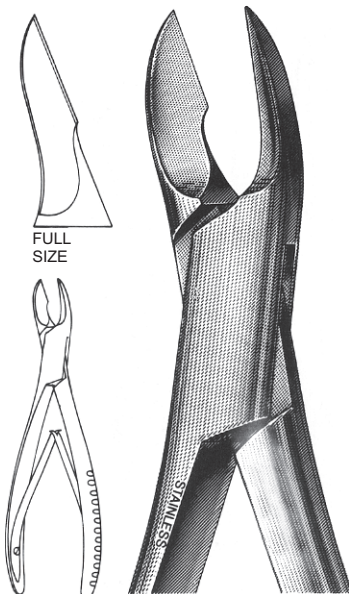

**36-179**  
No. 5A-Side Cutting, 6 1/2"

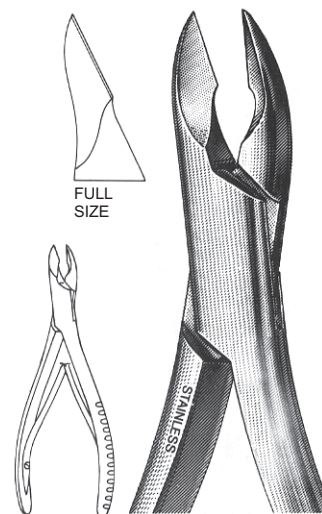

**36-180**  
No. 5S-Side Cutting, 6"

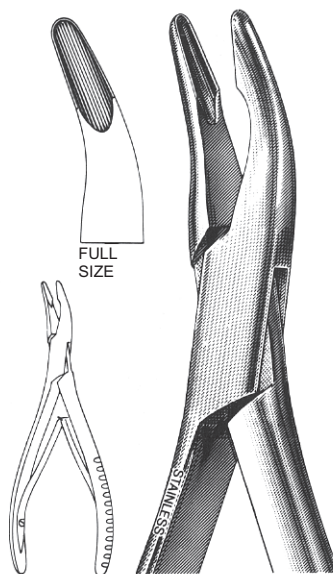

**36-181**  
No. 1A-MEAD, 6 1/2"

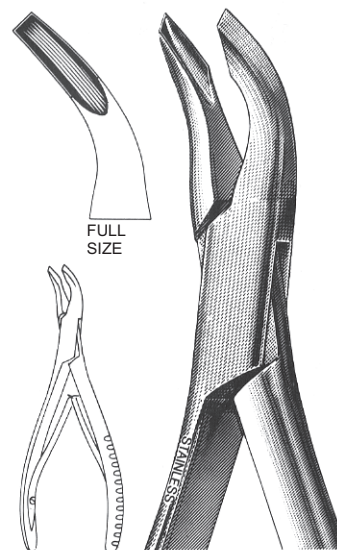

**36-182**  
No. 2A-MEAD, Square  
Tips, 6 1/2"



# Rongeurs

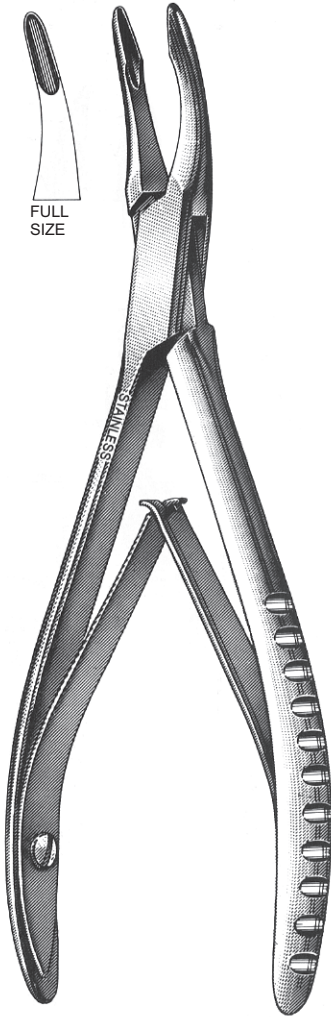
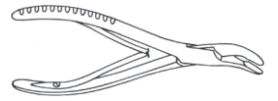

**36-183**  
FRIEDMAN 5 1/2"

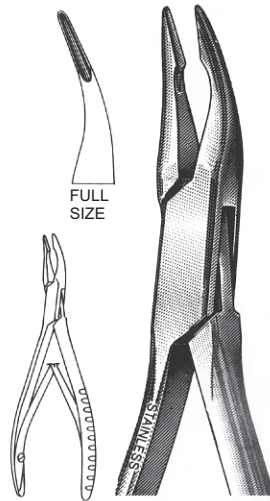

**36-184**  
MICRO-FRIEDMAN 5 1/2"  
15° Curved Jaws

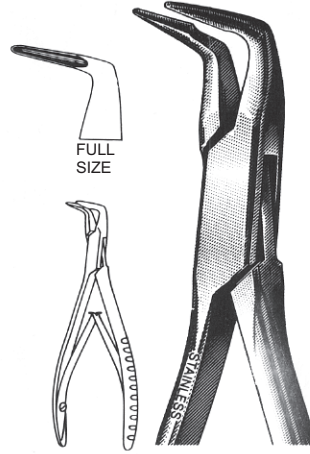

**36-185**  
MICRO-FRIEDMAN 5 1/2"  
90° Angled Jaws

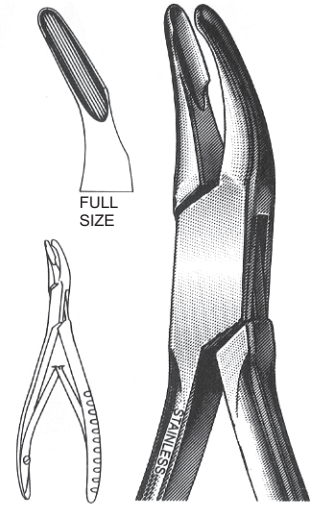

**36-186**  
No. 4-5 1/2"

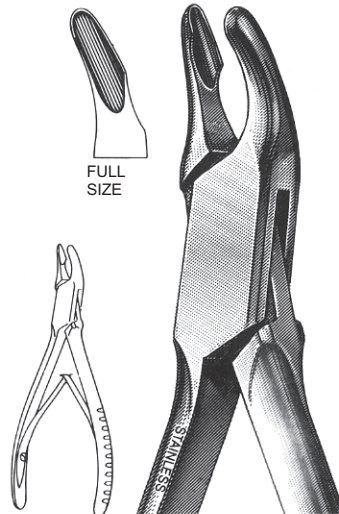

**36-187**  
No. 4A-6 1/2"

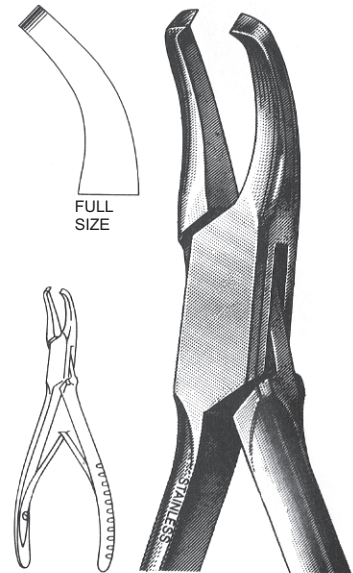

**36-188**  
No 6A-End Cutting 6 1/2"



# Rongeurs

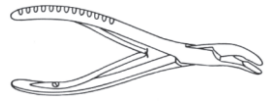

**36-189**  
BEYER-Double Action, 7"



**36-190**  
No. 1, 6 1/2"

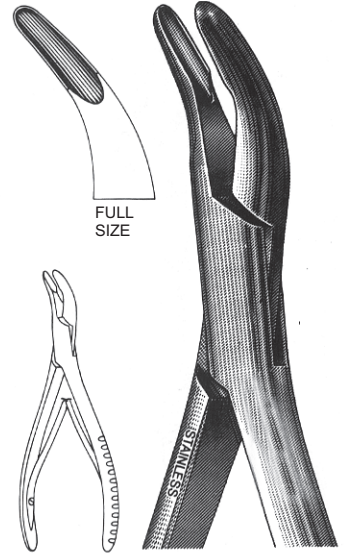

**36-191**  
HARTMAN 5 3/4" , Strong Curve

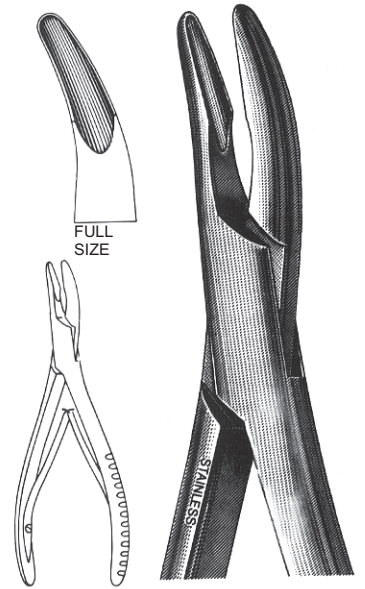

**36-192**  
BANE 7" , Slight Curve



# Bone Curettes



## LUCAS

## MOLT

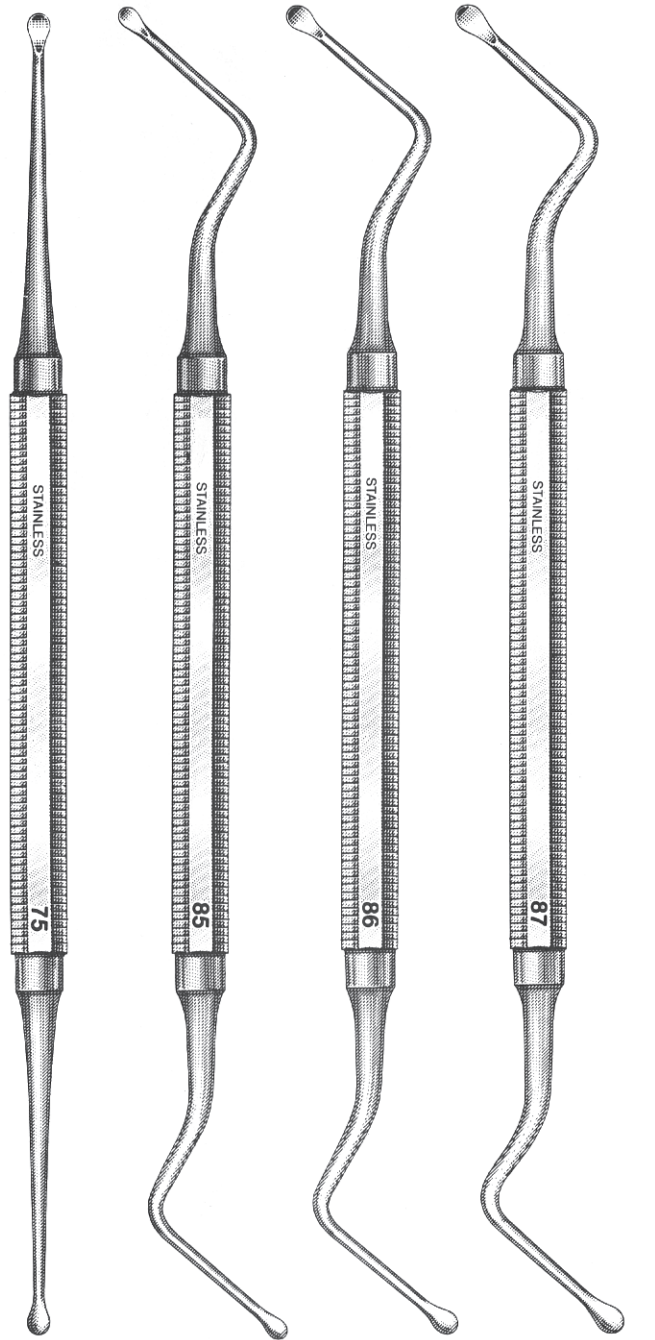

43-193 #75      43-194 #85      43-195 #86      43-196 #87

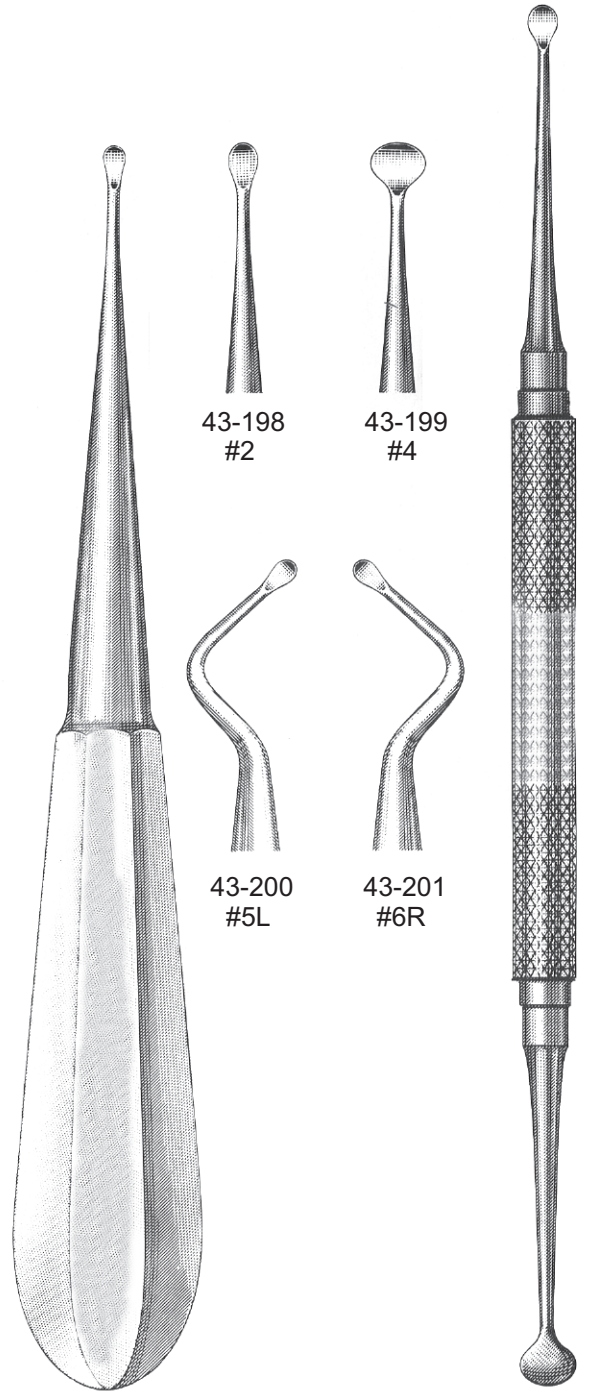

43-197 #1      43-198 #2      43-199 #4      43-200 #5L      43-201 #6R      43-202 #2/4



# Bone Files

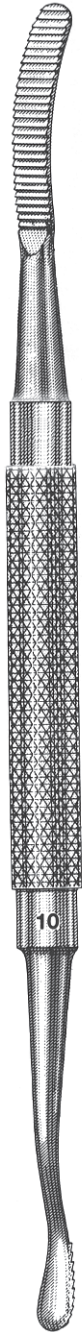
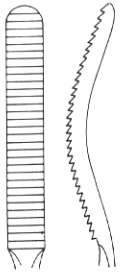

**43-203**  
#10

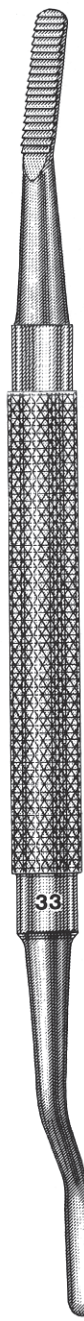
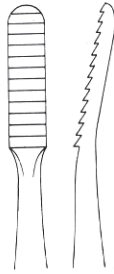

**43-204**  
#33

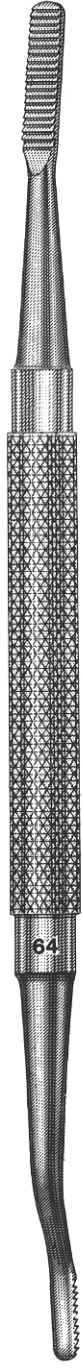
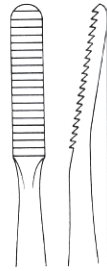

**43-205**  
#64-MILLER

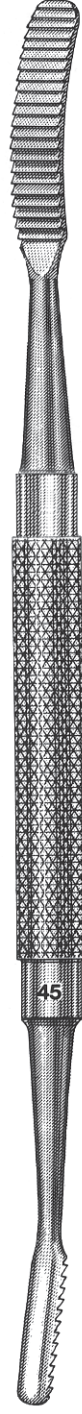
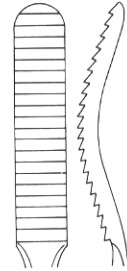

**43-206**  
#45-MILLER

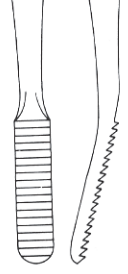
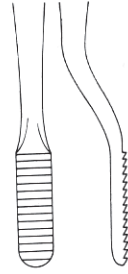



# Bone Files

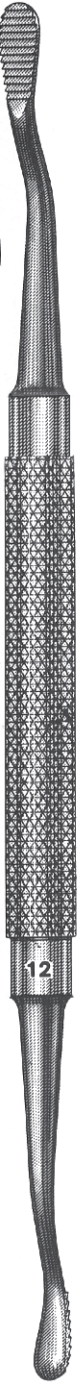
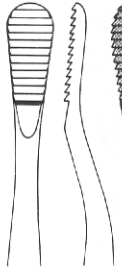

**43-207**  
**#12-HOWARD**

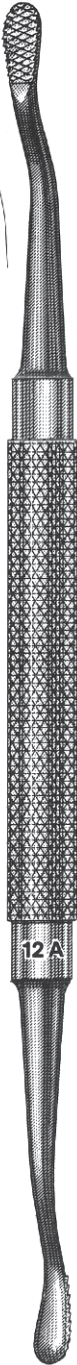
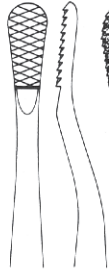

**43-208**  
**#12A**

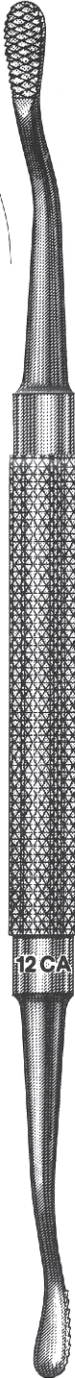
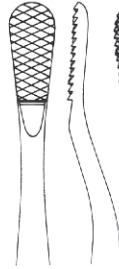

**43-209**  
**#12CA**

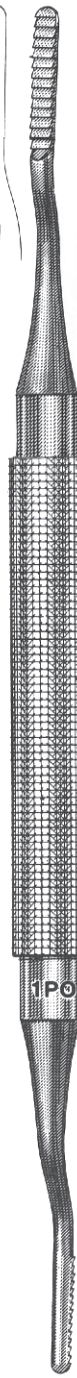
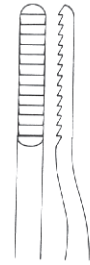

**43-210**  
**#1-POLOKOFF**





# Bone Chisels



## GARDNER

## BUCKLEY

## WAKEFIELD

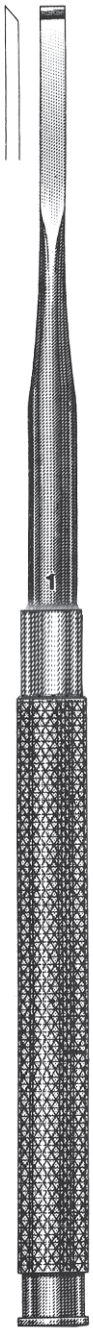

43-211  
Gardner  
#1

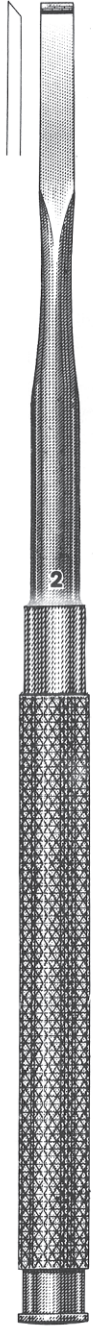

43-212  
Gardner  
#2

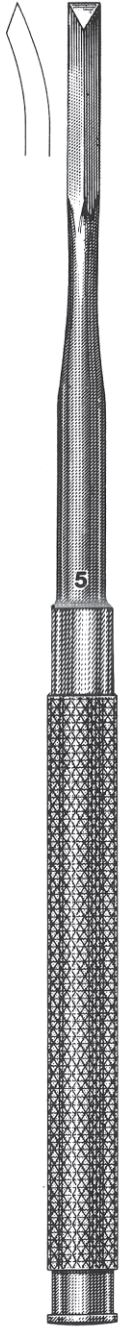

43-213  
Gardner  
#5



43-214  
Gardner  
#5R

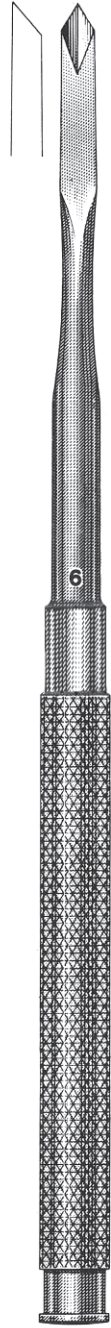

43-215  
Gardner  
#6



43-216  
Buckley  
#3

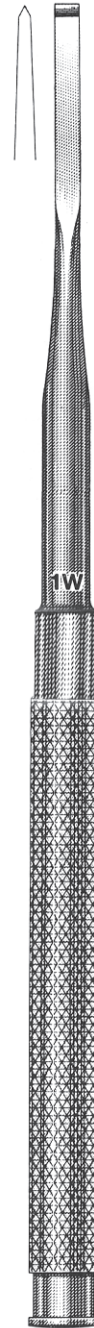

43-217  
Wakefield  
#1W

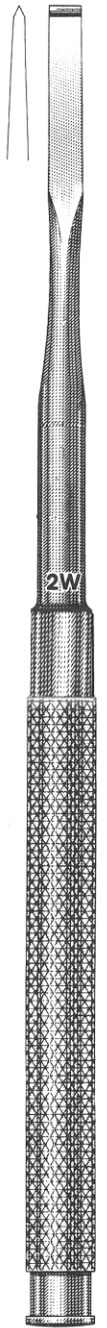

43-218  
Wakefield  
#2W



## Mallets

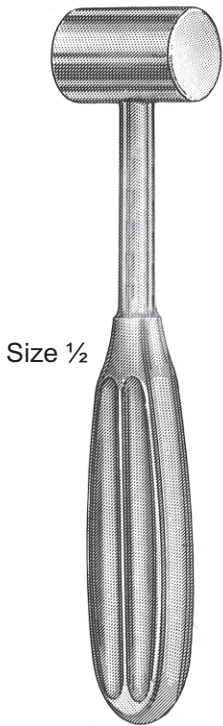

Size ½

**44-219**  
GERZOG Mallet 7 ½"  
head 8 oz. Lead filled with  
stainless jacket

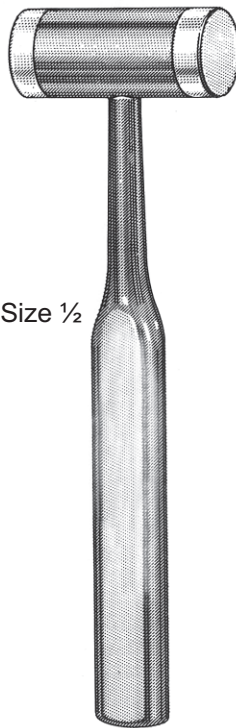

Size ½

**44-220**  
Mallet 7 ½" ,lightweight 7.5 oz  
stainless head 1" dia. With  
2 replaceable nylon caps  
**44-221**  
Nylon Cap Replacement

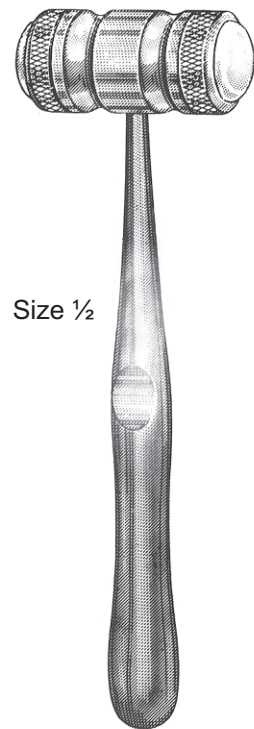

Size ½

**44-222**  
MEAD Mallet 7 ½" ,head 8 oz.  
With 2 replaceable nylon caps  
**44-223**  
Nylon Cap Replacement





## Bone Holding Forceps



### KERN

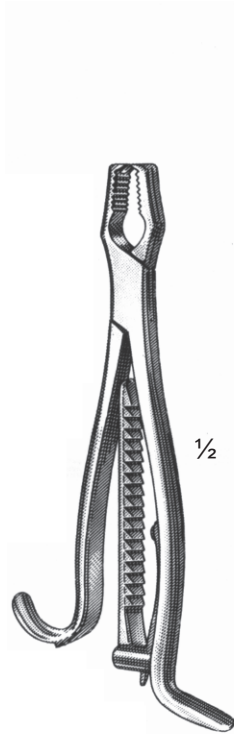

**44-224**

Baby Kern Bone Holding Forceps,  
6" , with ratchet

### DINGMAN

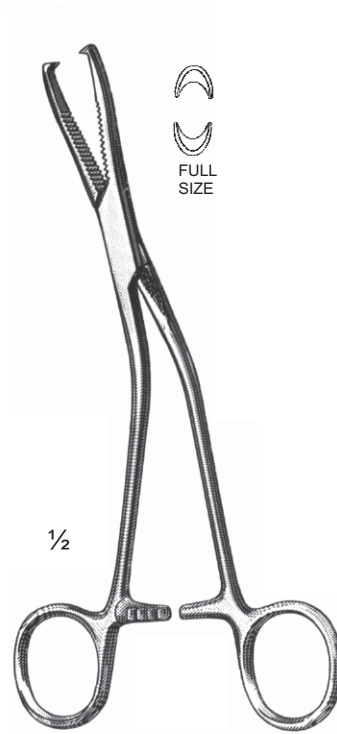

**44-225**

DINGMAN Bone Forceps, 7 1/2" ,  
angled on side, 2x2 teeth



## Lip and Cheek Retractors

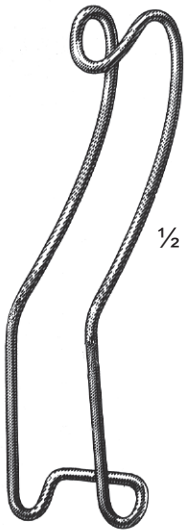

**47-226**  
Lip Retractor 6"  
double end 25mm and  
36mm wide

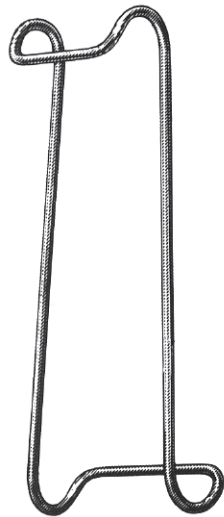

**47-227**  
Columbia Lip Retractor  
5 1/2" , double end 37mm and  
50mm wide



**47-228**  
University of Minnesota  
Cheek Retractor



**46-229**  
Cheek Retractor 7 3/4" ,  
with swivel blade  
35mm wide



# Tongue Seizing Forceps and Tongue Depressors

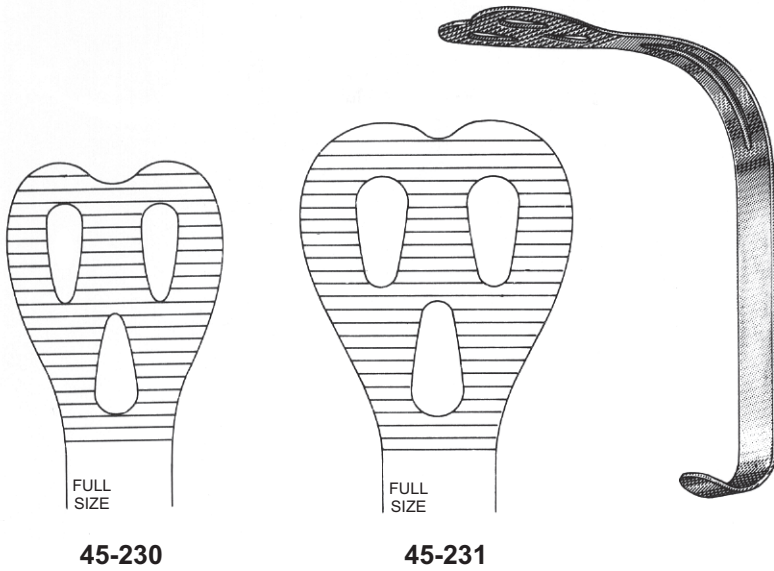
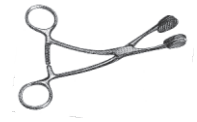

SIZE 1/2

**45-230**

WIEDER Tongue Depressor,  
small blade 28mm wide,  
serrated

**45-231**

WIEDER Tongue Depressor,  
large blade 36mm wide,  
serrated

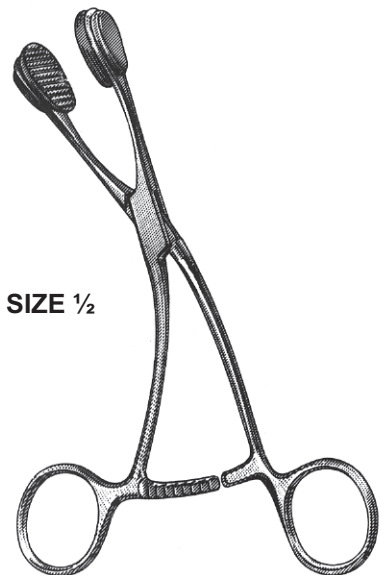

SIZE 1/2

**45-232**

YOUNG Tongue Seizing Forceps

**45-233**

Rubber Jaws-Replacement

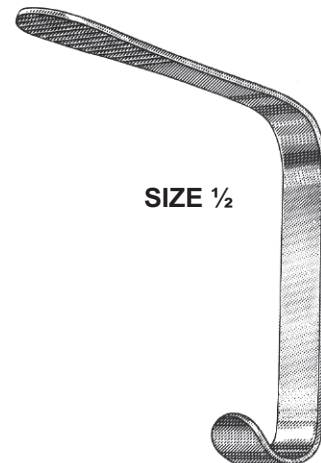

SIZE 1/2

**45-234**

ANDREWS Tongue Depressor  
serrated blade 21mm wide



# Mouth Gags

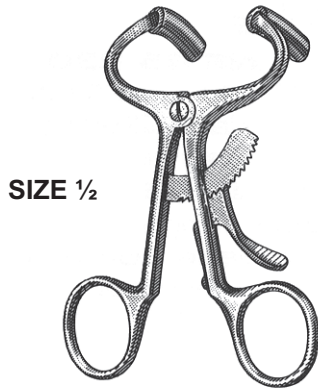

SIZE 1/2

**37-235**  
MOLT, PEDIATRIC

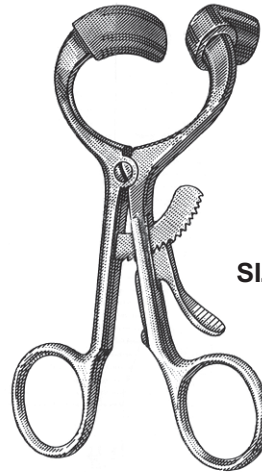

SIZE 1/2

**37-236**  
MOLT, CHILD

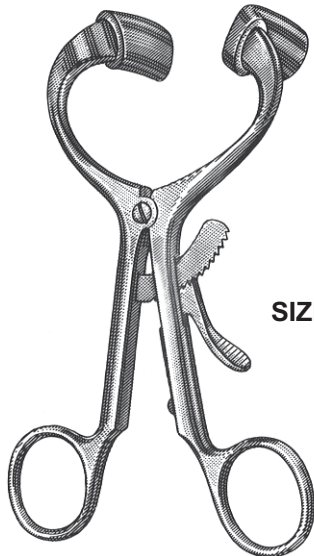

SIZE 1/2

**37-237**  
MOLT, ADULT

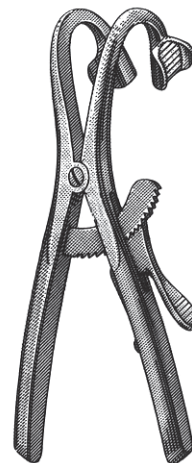

SIZE 1/2

**37-238**  
DENHARDT



# Gum Scissors



SIZE 1/2

**38-239**  
DEAN 6 3/4" , One  
Serrated Blade



SIZE 1/2

**38-240**  
HEATH 6 1/4" , One  
Serrated Blade

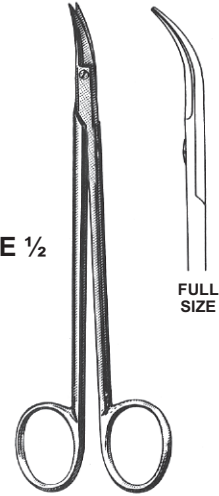

SIZE 1/2

FULL  
SIZE

**38-241**  
QUIMBY 5"  
**38-242**  
QUIMBY 5" , One  
Serrated Blade  
(not illustrated)

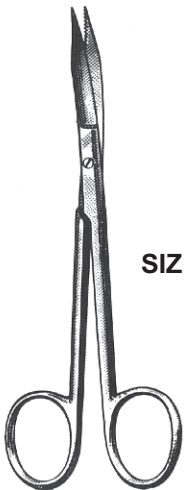

SIZE 1/2

**38-243**  
G-F 5" , Curved Fine Tips,  
One Serrated Blade

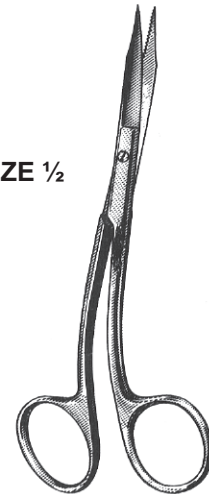

SIZE 1/2

**5-243-TC**  
G-F 5" , One Serrated  
and One Tungsten carbide Blade

**38-244**  
5" , Double Curved,  
One Serrated Blade



# Gum Scissors



SIZE 1/2

**38-239**  
DEAN 6 3/4" , One  
Serrated Blade

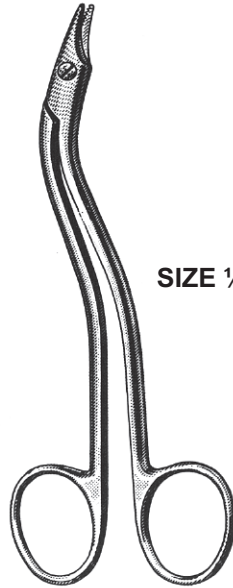

SIZE 1/2

**38-240**  
HEATH 6 1/4" , One  
Serrated Blade

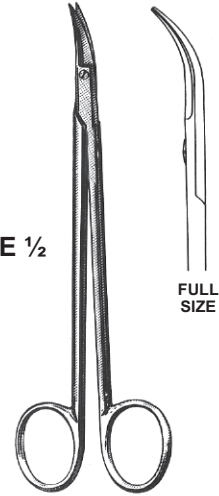

SIZE 1/2

FULL  
SIZE

**38-241**  
QUIMBY 5"  
**38-242**  
QUIMBY 5" , One  
Serrated Blade  
(not illustrated)

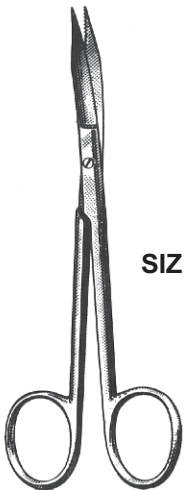

SIZE 1/2

**38-243**  
G-F 5" , Curved Fine Tips,  
One Serrated Blade

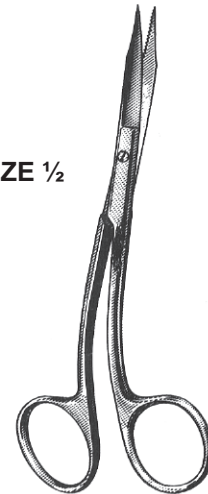

SIZE 1/2

**5-243-TC**  
G-F 5" , One Serrated  
and One Tungsten carbide Blade

**38-244**  
5" , Double Curved,  
One Serrated Blade



# Gum Scissors



SIZE 1/2

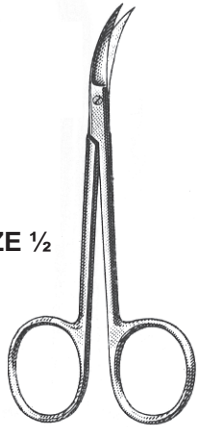

**38-253**  
IRIS 4 1/2" , Curved  
Sideways

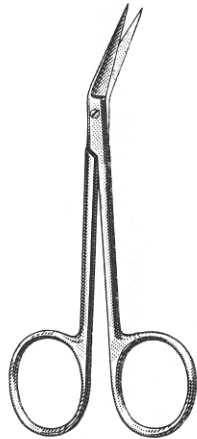

**38-254**  
IRIS 4 1/2" , Angled  
on Side

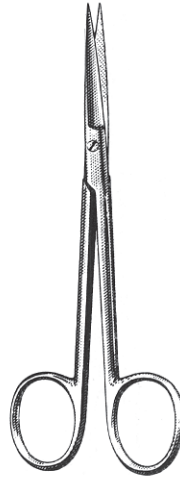

**WAGNER 4 3/4" , S/S**  
38-255 Straight, Smooth  
38-256 Straight, One  
Serrated Blade

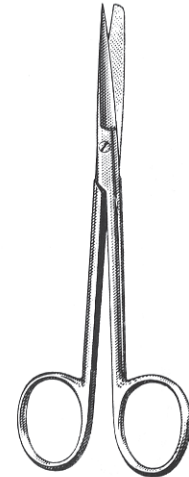

**WAGNER 4 3/4" , S/B**  
38-257 Straight, Smooth  
38-258 Straight, One  
Serrated Blade

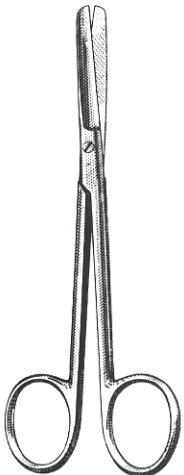

**WAGNER 4 3/4" , B/B**  
38-259 Strt, Smooth  
38-260 Straight, One  
Serrated Blade

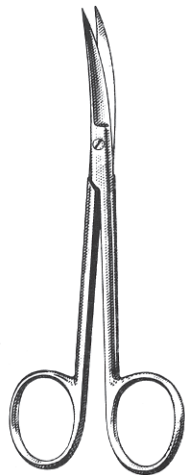

**WAGNER 4 3/4" , S/S**  
38-261 Curved, Smooth  
38-262 Curved , One  
Serrated Blade

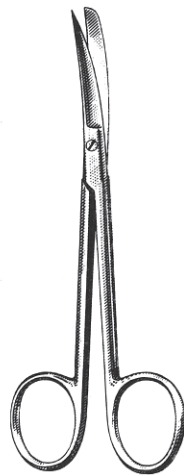

**WAGNER 4 3/4" , S/B**  
38-263 Curved, Smooth  
38-264 Curved, One  
Serrated Blade

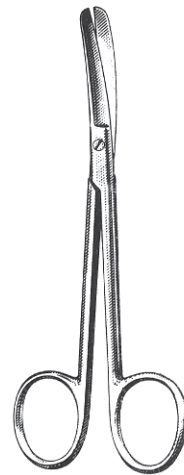

**WAGNER 4 3/4" , B/B**  
38-265 Curved, Smooth  
38-266 Curved, One  
Serrated Blade

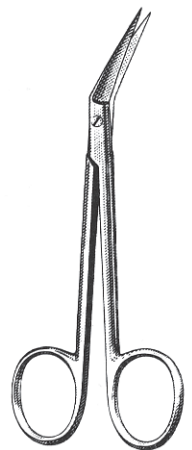

**WAGNER 4 3/4" , S/S**  
38-267 Ang., Smooth  
38-268 Angular, One  
Serrated Blade



## Gum Scissors



**38-270**  
LA GRANGE, 4 1/4" , Impro  
One Serrated Blade

SIZE 1/2

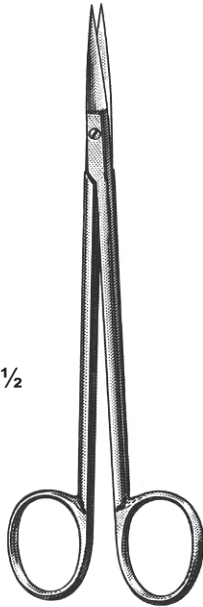

**KELLY 6 1/4" , S/S**  
38-271 Straight, Smooth  
38-272 Straight, One  
Serrated Blade



**KELLY 5 3/4" , S/S**  
38-273 Curved, Smooth  
38-274 Curved, One  
Serrated Blade



**KELLY 6 1/4" , S/S**  
38-275 Angular, Smooth  
38-276 Angular, One  
Serrated Blade

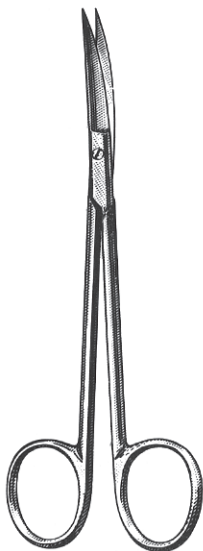

**JOSEPH 5 3/4" , S/S**  
38-277 Straight, Smooth  
38-278 Curved, Smooth

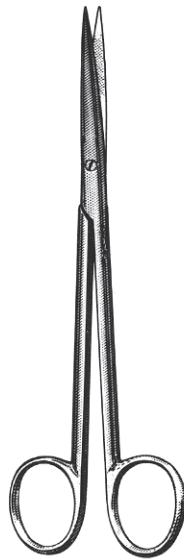

**SULLIVAN 5 1/2" , S/S**  
38-279 Straight, Smooth

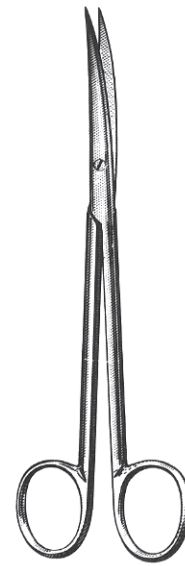

**SULLIVAN 5 1/2" , S/S**  
38-280 Curved, Smooth  
38-281 Curved, One  
Serrated Blade





# Gum and Bandage Scissors



38-282  
ROSS, 4 3/4" , Curved,  
Periodontal



38-283  
CASTROVIEJO, 3 1/2" ,  
Curved, Perierodontal

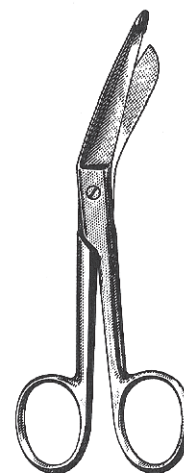

**LISTER BANDAGE**  
38-286 4 1/2"  
38-287 5 1/2"  
38-288 7 1/4"

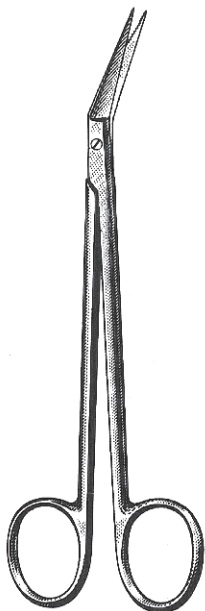

38-284  
LOCKLIN 6 1/4"  
Straight Shanks,  
One Serrated Blade

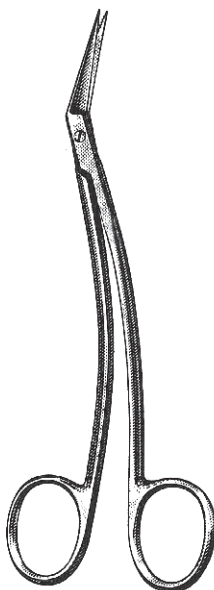

38-285  
LOCKLIN 6 1/4" ,  
Curved Shanks,  
One Serrated Blade

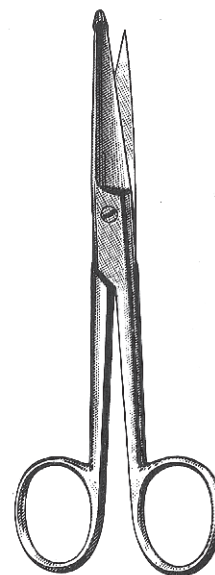

38-289  
KNOWLES BANDAGE 5 1/2"



# Surgical Scissors



Size 1/2

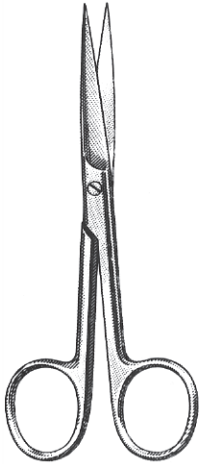

**38-290**  
4 1/2" , Straight, S/S  
**38-291**  
5 1/2" , Straight, S/S

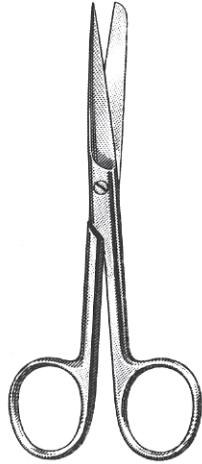

**38-292**  
4 1/2" , Straight, S/B  
**38-293**  
5 1/2" , Straight, S/B

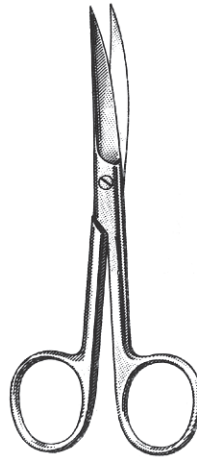

**38-294**  
4 1/2" , Curved, S/S  
**38-295**  
5 1/2" , Curved, S/S

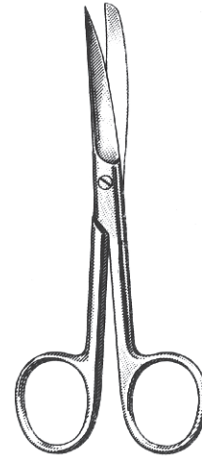

**38-296**  
4 1/2" , Curved, S/B  
**38-297**  
5 1/2" , Curved, S/B

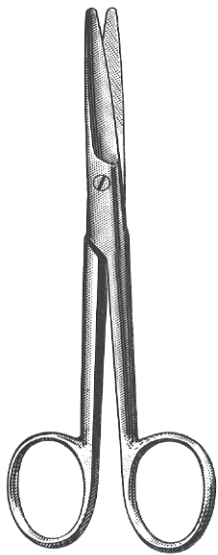

**38-298**  
MAYO 5 1/2" , Straight

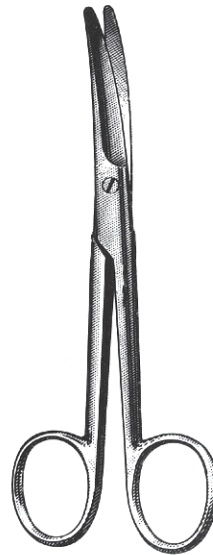

**38-299**  
MAYO 5 1/2" , Curved



## Suture Scissors

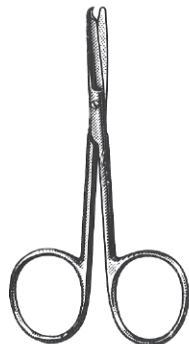

**NS 38-300**  
SPENCER 3 1/2"



**NS 38-301**  
LITTAUER JR., 4 1/2"

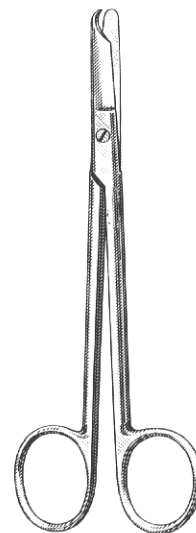

**NS 38-302**  
LITTAUER  
STANDARD, 5 1/2"

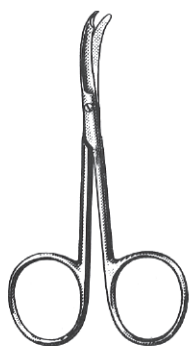

**NS 38-303**  
SHORTBENT 3 1/2"

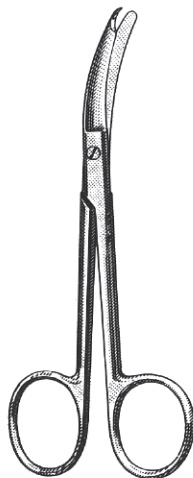

**NS 38-304**  
NORTHBENT 4 3/4"

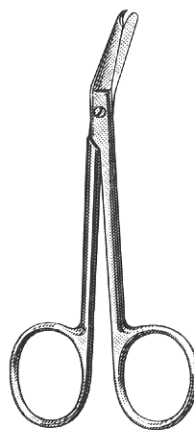

**NS 38-305**  
NS 4 1/2" , Angular  
(Also ideal for cutting  
retraction cord)

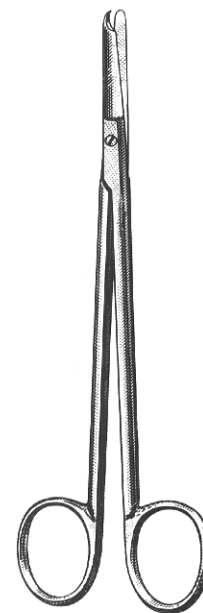

**NS 38-306**  
LONG 6 1/4"



# Collar and Crown, Wire Cutting Scissors



Size 1/2

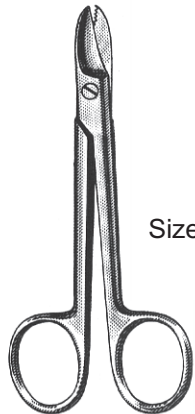

Size 1/2

**38-307**  
4 1/4" , Straight,  
One Serrated Blade  
**38-308**  
4 1/4" , Straight, Smooth

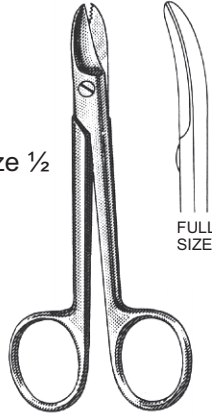

Size 1/2

FULL  
SIZE

**38-309**  
4 1/4" , Curved,  
One Serrated Blade  
**38-310**  
4 1/4" , Curved, Smooth

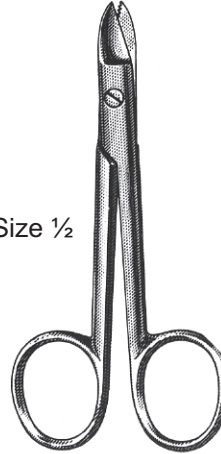

Size 1/2

**38-311**  
4 3/4" , Straight,  
One Serrated Blade  
**38-312**  
4 3/4" , Straight, Smooth

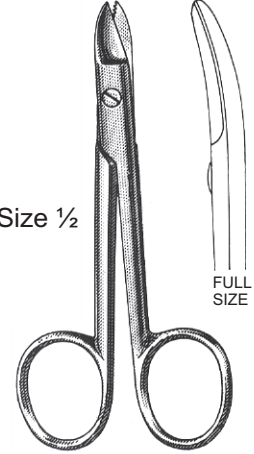

Size 1/2

FULL  
SIZE

**38-313**  
4 3/4" , Curved,  
One Serrated Blade  
**38-314**  
4 3/4" , Curved, Smooth

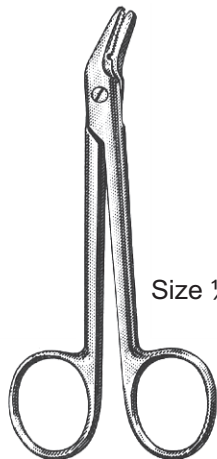

Size 1/2

**38-315**  
4 3/4" , Angular With Wire Cutter,  
One Serrated Blade

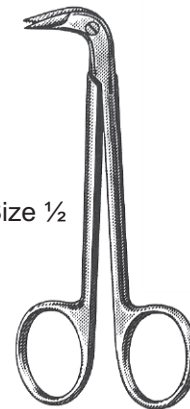

Size 1/2

**38-316**  
RA Matrix 4 1/4" ,  
One Serrated Blade



# Tissue Forceps



Size 1/2

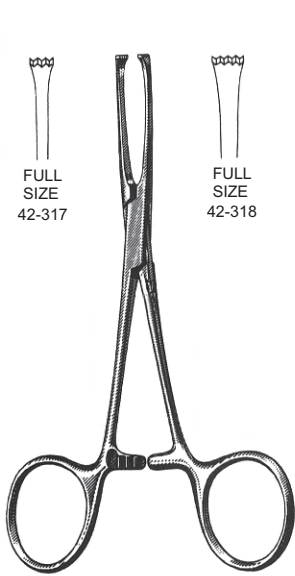

**BABY ALLIS**  
 42-317 5" , straight, 4x5, teeth Extra delicate  
 42-318 5 1/2" , straight, 4x5 teeth

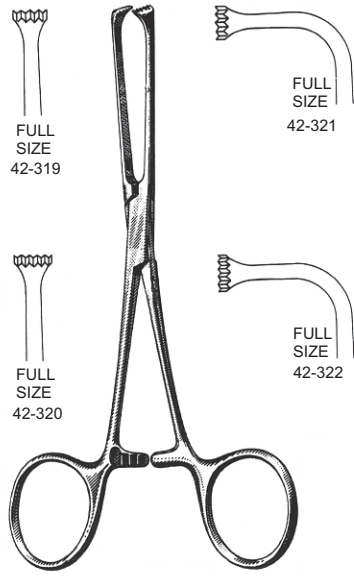

**ALLIS**  
 42-319 6" , Straight, 4x5 teeth  
 42-320 6" , Straight, 5x6 teeth  
 42-321 6" , Angular, 4x5 teeth  
 42-322 6" , Angular, 5x6 teeth



42-323 5 1/2" , Tissue, 1x2 teeth  
 42-324 6" , Tissue, 1x2 teeth



**SEMKIN**  
 42-325 6" , straight, 1x2 teeth  
 42-326 5" , curved, 1x2 teeth (Not Illus.)



**42-327**  
**ADSON** 4 3/4" , 1x2 teeth



**42-328**  
**BROWN-ADSON** 4 3/4" , 7x7 teeth



**42-329**  
**BROWN** 6" , 8x8 teeth



**RUSSIAN**  
 42-330 6"  
 42-331 8"



**42-332**  
**Extra-Delicate**, 4" straight, 1x2 teeth



# Dressing Forceps and Furnace Tongs



Size 1/2



42-333 5 1/2" , Dressing  
42-334 6" , Dressing



42-335  
SEMKIN 5" , Serrated  
42-336  
SEMKIN 6" , Serrated



42-337  
6" , Dressing, delicate,  
Cross Serrated  
T-Carbide Jaws



42-338  
4" , Dressing, Extra  
dedicate tips



42-339  
ADSON 4 3/4" ,  
Dressing

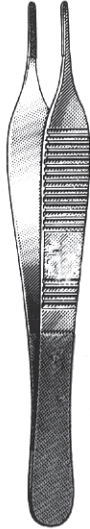

42-340 TC  
ADSON 4 3/4" ,  
Dressing, T-Carbide Jaws



42-341 A  
ADSON 4 3/4" ,  
Dressing, Angled Jaws

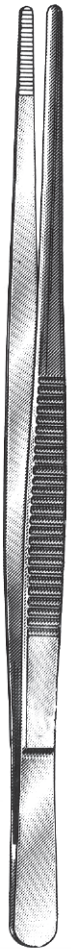

FURNACE TONGS  
42-342 10"  
42-343 12"



# Tissue Retractors and Hooks



Size 1/2



**48-344**  
3 Sharp Prongs

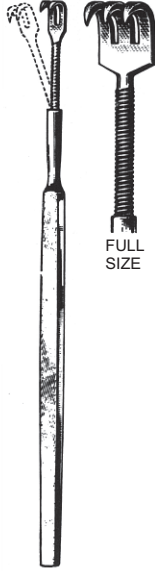

**48-345**  
6" ,2 Sharp Prongs  
**48-346**  
6" ,3 Sharp Prongs



**48-347**  
6" ,2 Sharp Prongs  
**48-348**  
6" ,3 Sharp Prongs



**48-349**  
SENN 6 3/8"  
3 Sharp Prongs



**48-350**  
5 1/2"  
Tissue Fixator



**48-351**  
FRAZIER 5" , Sharp  
**48-352**  
FRAZIER 5" , Blunt



## Towel Clamps and Napkin Holders



Size ½



**49-353**  
JONES 3 ½"

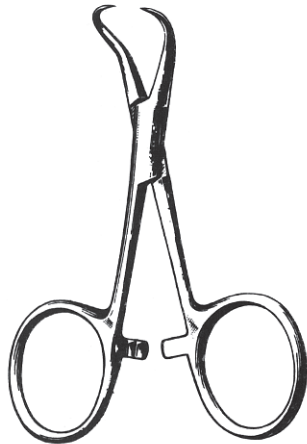

**49-354**  
BACKHAUS 3 ½"

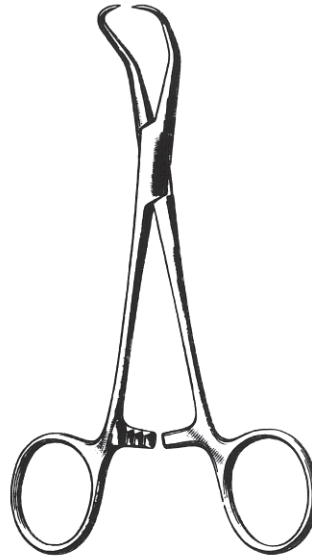

**49-355**  
BACKHAUS 5 ¼"



NON-PERFORATING  
**49-356**  
LORNA 3 ½"  
**49-357**  
LORNA 5 ¼"  
(Good on Paper Drapes)





# Hemostatic Forceps



Size 1/2

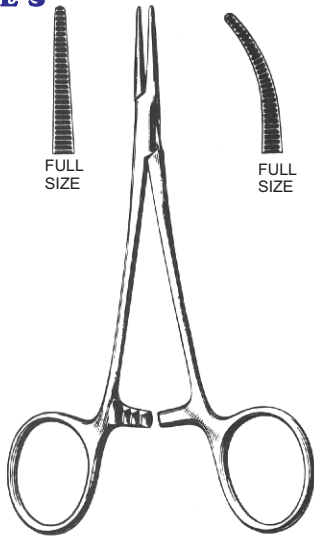

**39-358**  
HALSTED Mosquito 5"  
Straight

**39-359**  
HALSTED Mosquito 5"  
Curved

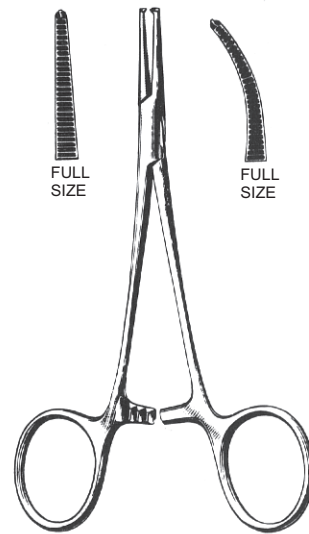

**39-360**  
HALSTED Mosquito 5"  
Straight, 1x2 Teeth

**39-361**  
HALSTED Mosquito 5"  
Curved, 1x2 Teeth

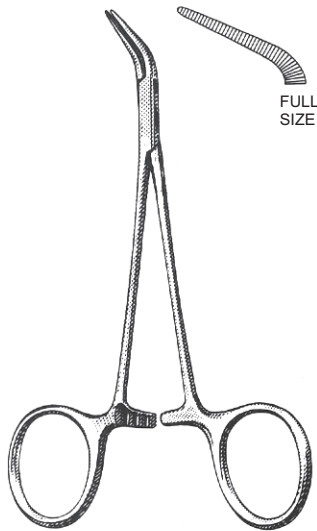

**39-362**  
HALSTED Mosquito 5"  
Jaws 45° Angled On Flat  
Extra Delicate

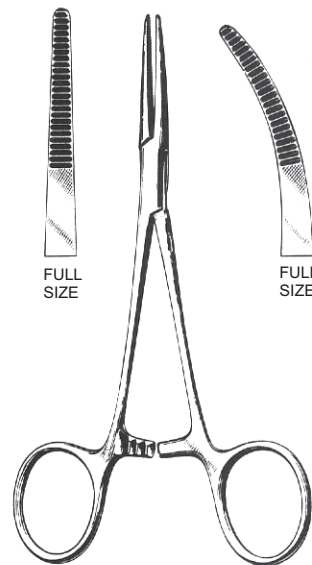

**39-363**  
KELLY 5 1/2"  
Straight

**39-364**  
KELLY 5 1/2"  
Curved



# Needle Holders



Size 1/2

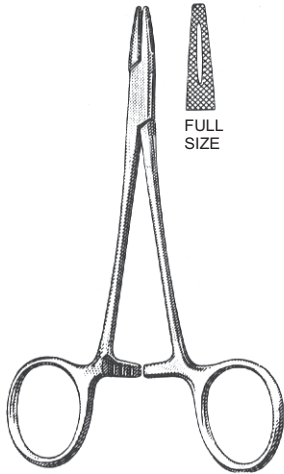

**40-365**  
COLLIER 5"  
Fenestrated Jaws

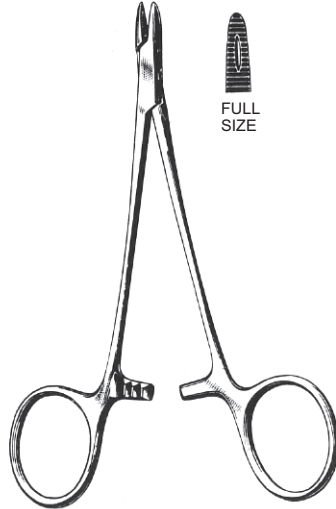

**40-366**  
DERF 4 3/4"

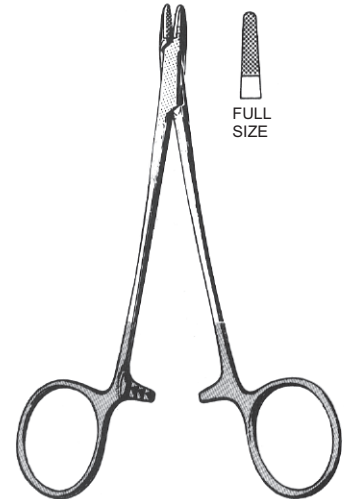

**40-367**  
DERF 4 3/4"  
T-Carbide Jaws



**40-368**  
WEBSTER 5"  
Delicate Smooth Jaws

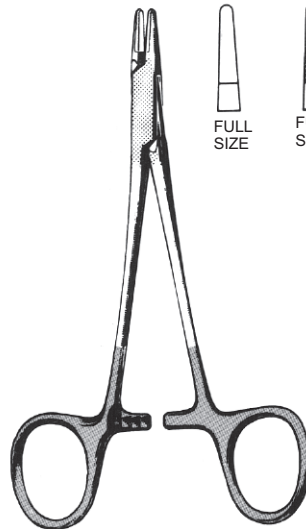

**40-369 TC**  
HALSEY 5"  
T-Carbide Smooth Jaws  
**40-370 TC**  
HALSEY 5"  
T-Carbide Serrated Jaws

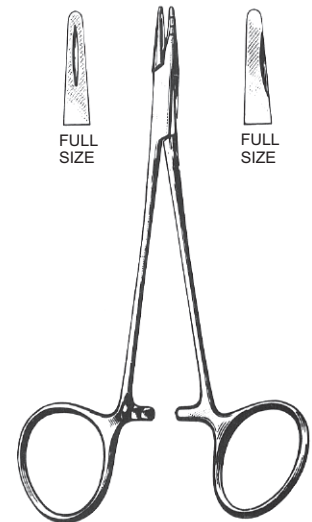

**40-371**  
NEIVERT 5"  
One Offset Ring



# Needle Holders

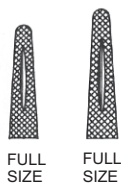
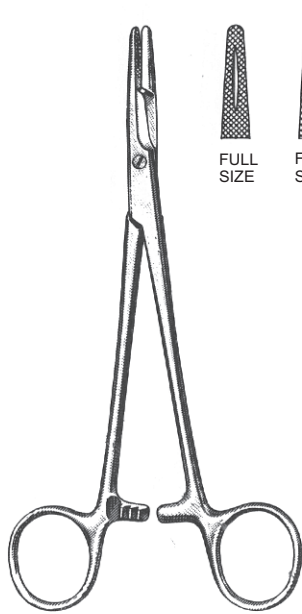

**40-372**  
OLSEN-HEGAR 5 1/2"  
**40-373**  
OLSEN-HEGAR 6 1/2"

Size 1/2

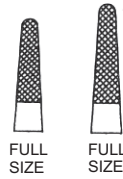

**40-374 TC**  
OLSEN-HEGAR 5 1/2"  
T-CARBIDE JAWS  
**40-375 TC**  
OLSEN-HEGAR 6 1/2"  
T-CARBIDE JAWS

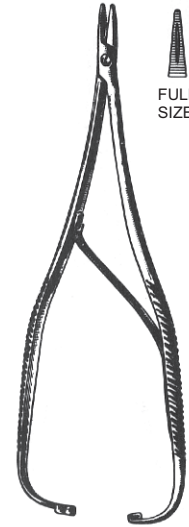

**40-376**  
BOYNTON 5"

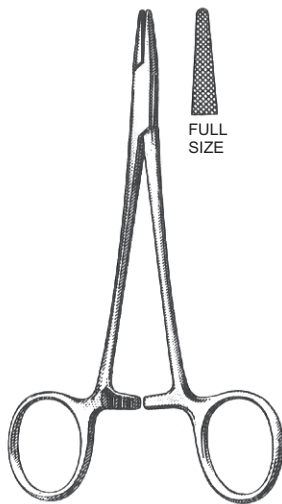

**40-377**  
GARDNER 5"

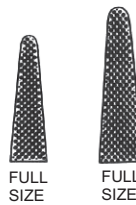
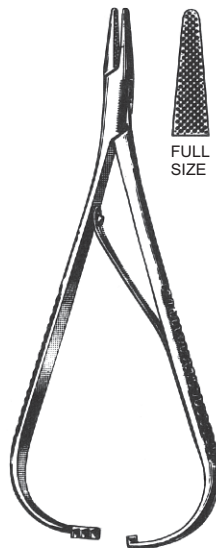

**40-378**  
MATHIEU 5 1/2"  
**40-379**  
MATHIEU 6 1/4"

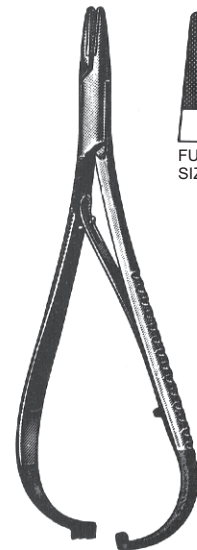

**40-380 TC**  
MATHIEU 5 1/2"  
T-CARBIDE JAWS



# Needle Holders



40-381  
BAUMGARTNER 5 "



40-382 TC  
BAUMGARTNER 5 "  
T-Carbide Jaws



40-383  
MAYO-HEGAR 5"  
40-384  
MAYO-HEGAR 6"



40-385 TC  
MAYO-HEGAR 5"  
40-386 TC  
MAYO-HEGAR 6"  
T-Carbide Jaws

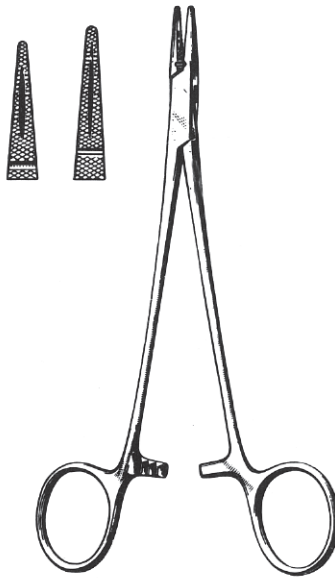

40-387  
CRILE-WOOD 6"  
40-388  
CRILE-WOOD 7"



40-389  
CRILE-WOOD 6"  
T-Carbide Jaws



# Needle Holders

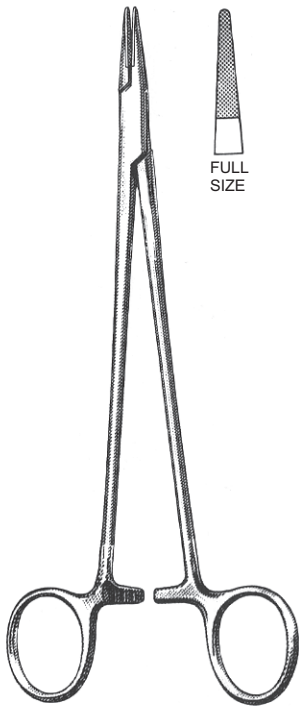
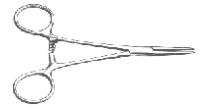

**40-390 TC**  
CRILE-WOOD 7"  
T-Carbide Jaws



**40-391 TC**  
RYDER-Type 5"  
T-Carbide Jaws

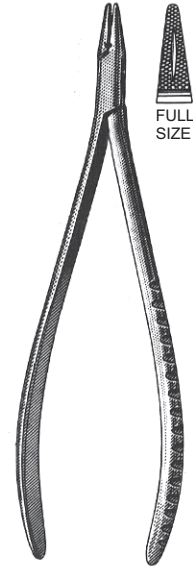

**40-392**  
CRILE 6"



**40-393**  
RYDER 6"  
T-Carbide Jaws



**40-394**  
WEBSTER 5" Quick Release,  
Smooth T-Carbide Jaws



**40-395 TC**  
CRILE-WOOD 6" , Quick Release,  
T-Carbide Jaws  
**40-396 TC**  
CRILE-WOOD 7" , Quick Release,  
T-Carbide Jaws



# Needle Holders



SIZE 1/2

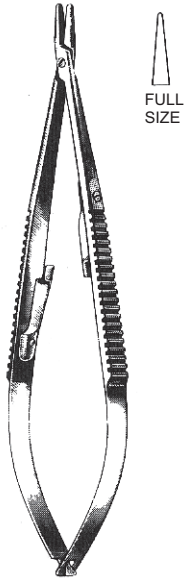

**40-397**  
CASTROVIEJO 5 1/2"  
Smooth Jaws

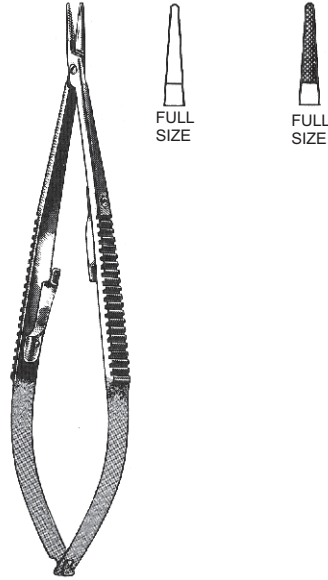

**40-398**  
CASTROVIEJO 5 1/2" , Straight, Smooth  
T-Carbide Jaws

**40-399**  
CASTROVIEJO 5 1/2" , Straight, Serrated  
T-Carbide Jaws

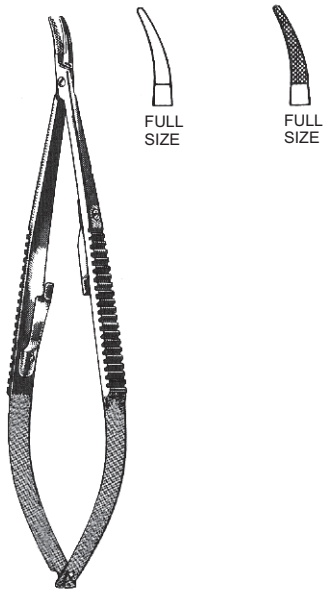

**40-400**  
CASTROVIEJO 5 1/2" , Curved, Smooth  
T-Carbide Jaws

**40-401**  
CASTROVIEJO 5 1/2" , Curved, Serrated  
T-Carbide Jaws



**40-402**  
STEVENS 6 1/2"









# Cotton and Dressing Pliers



## COLLEGE



**46-418**  
Standard Tips,  
Serrated



**46-419**  
Standard Tips,  
Smooth

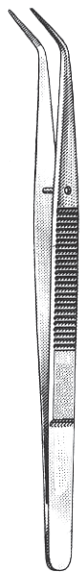

**46-420**  
Extra Fine Tips,  
Serrated



**46-421**  
Extra Fine Tips,  
Long, Serrated



**46-422**  
Standard Tips,  
Non-Pinch,  
Serrated



**46-423**  
Extra Fine Tips,  
Long, Non-Pinch,  
Serrated



**46-424**  
Forked Tips,  
Smooth



**46-425**  
MERIAM



**46-426**  
PERRY  
Curved Tips



**46-427**  
PERRY  
Angled Tips



**46-428**  
SELF-LOCKING  
Serrated Tips



**46-429**  
SELF-LOCKING  
Grooved Tips

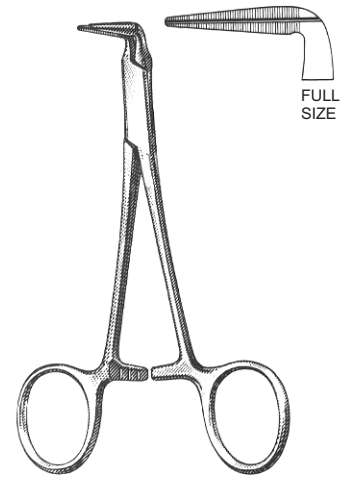

**46-430**  
SILVER-POINT HOLDING  
Grooved Tips

Dressing Pliers size



# Mouth Mirrors And Handles



### CONE SOCKET

- 46-431 Regular, Plane, 3,4 and 5
- 46-432 Regular, Magnifying, 3,4 and 5
- 46-433 FRONT-SURFACE, 3,4 and 5



### SIMPLE STEM

- 46-434 Regular, Plane, 3,4 and 5
- 46-435 Regular, Magnifying, 3,4 and 5
- 46-436 FRONT-SURFACE, 3,4 and 5



- 46-437 Octagonal, Cone Socket
- 46-438 Octagonal, Simple Stem

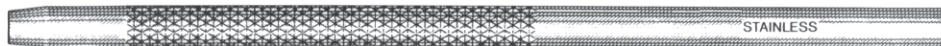

- 46-439 Deluxe, Cone Socket
- 46-440 Deluxe, Simple Stem



- 46-441 Octagonal, Cone Socket, with Millimeter Rule

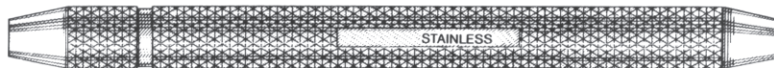

- 46-442 Double Ended for Cone Socket Points



- 46-443 # 4 and 5, White
- 46-444 # 4 and 5, Blue



# Gauges And Dividers

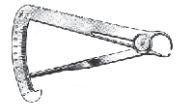

1/2

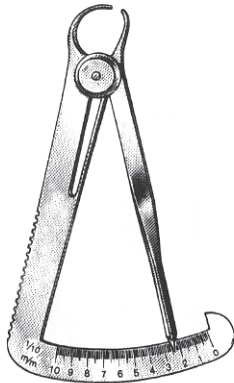

46-445  
Crown Gauge, Improved  
Model with 2 Sided Scale

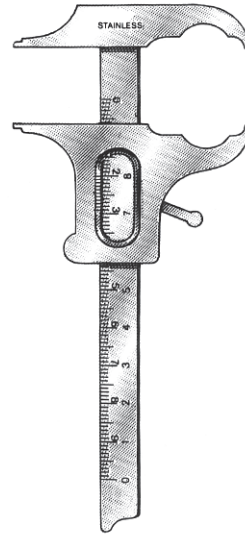

46-446  
BOLEY Gauge,  
STAINLESS

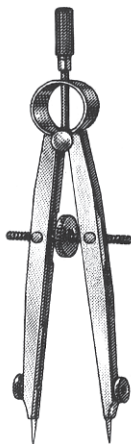

46-447  
Spring Bow Divider  
4 1/2" Radius

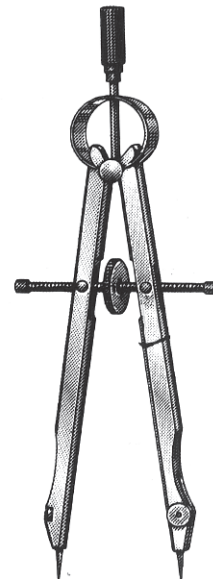

46-448  
Spring Bow Divider  
6" Radius

Shown size



# Explorers



50-449  
(1DE)

50-450  
(2DE)

50-451  
(3DE)

50-452  
(5DE)

50-453  
(6DE)

50-454  
(7DE)

50-455  
(3A SE)

50-456  
(6SE)

50-457  
(7SE)

50-458  
(17SE)

50-459  
(23SE)



# Explorers

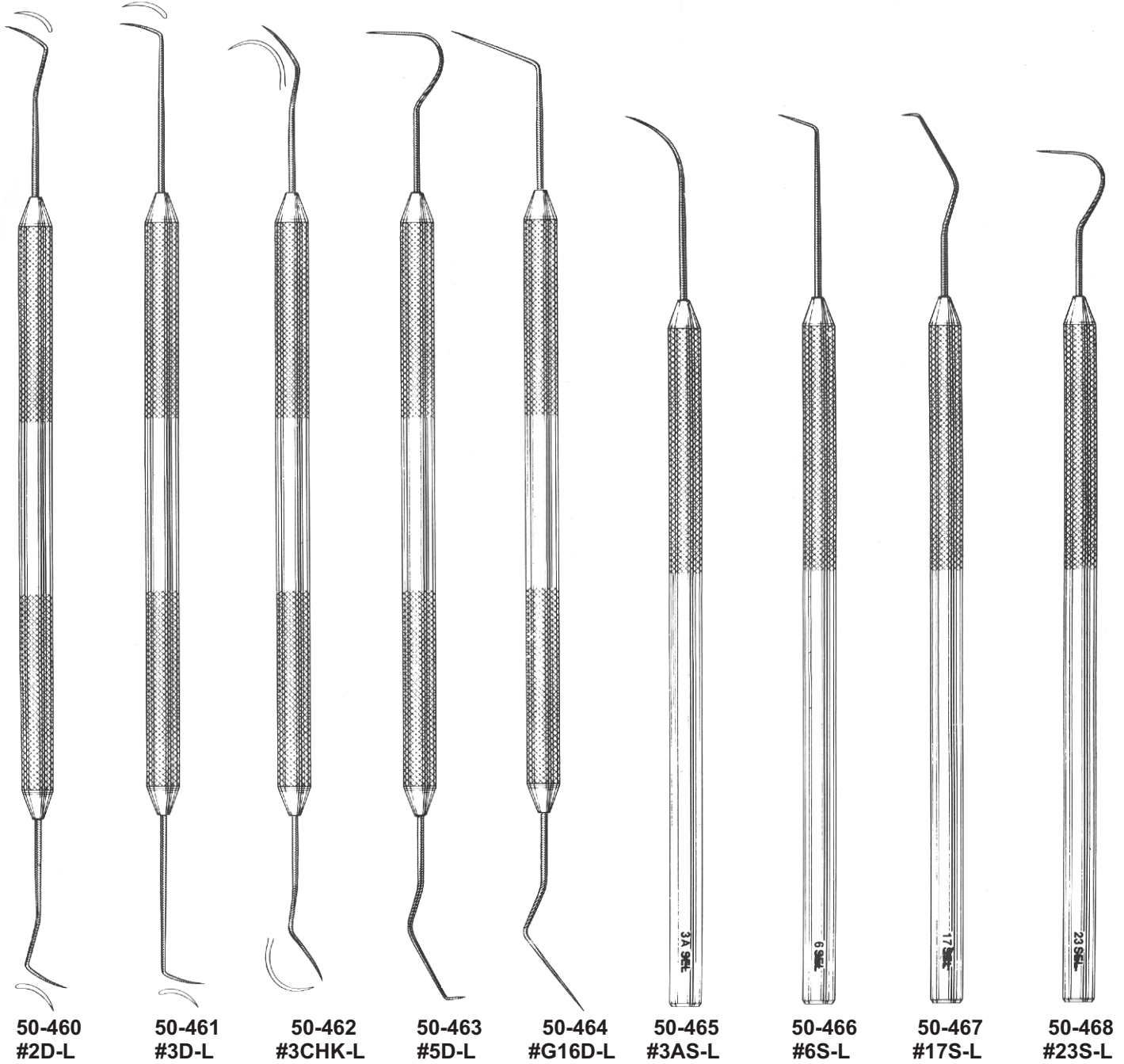

50-460  
#2D-L

50-461  
#3D-L

50-462  
#3CHK-L

50-463  
#5D-L

50-464  
#G16D-L

50-465  
#3AS-L

50-466  
#6S-L

50-467  
#17S-L

50-468  
#23S-L



# Probes and Explorer/Probes

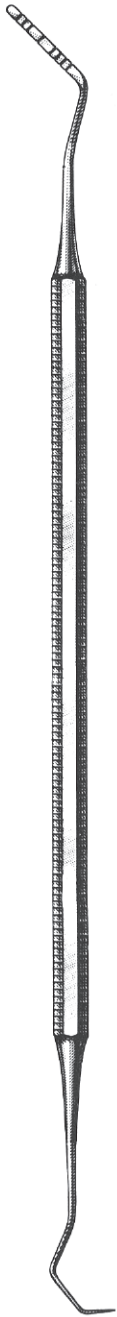

**50-469**  
Probe/Explorer  
(GF 17)

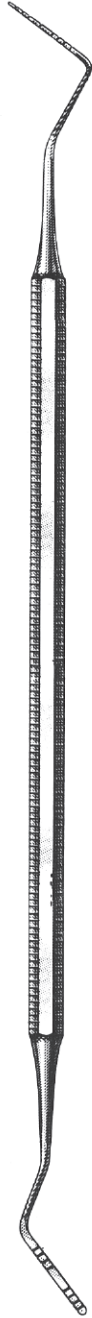

**50-470**  
Probe  
(GF 18)

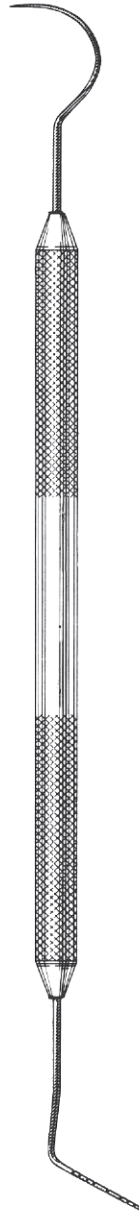

**50-471**  
Probe/Explorer  
(PE 1-23)

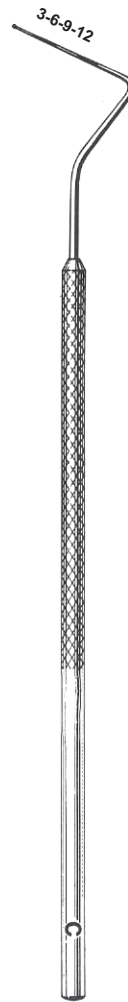

**50-472**  
Probe  
(C)

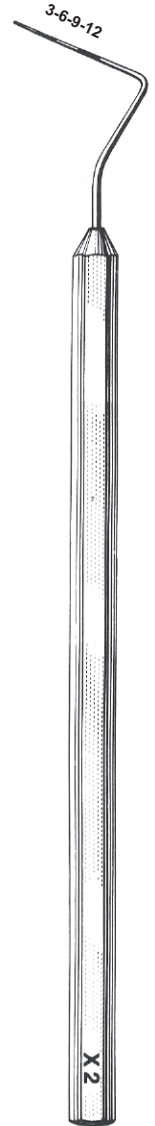

**50-473**  
Probe  
(X2)



# Excavators

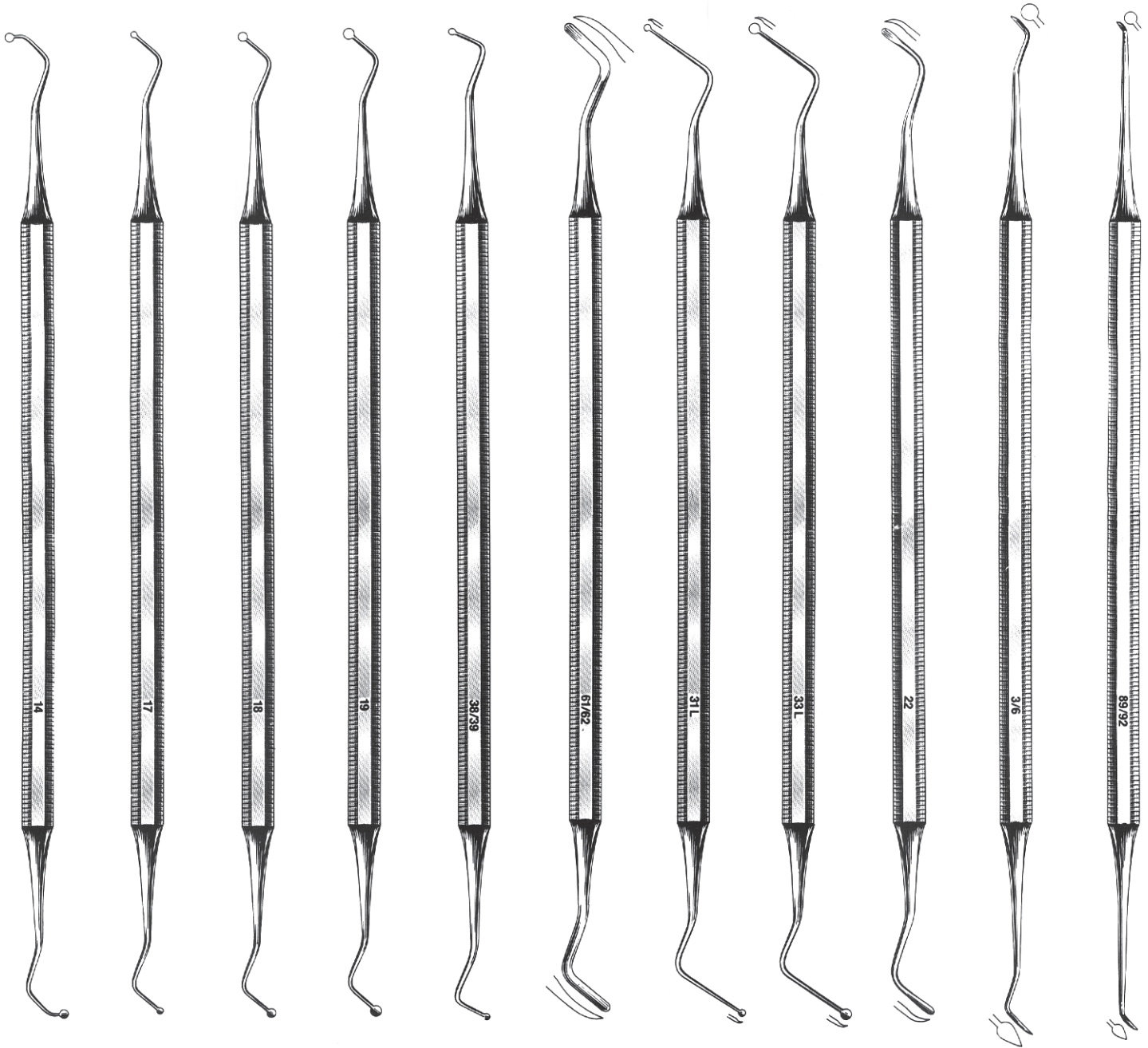

50-474  
#14

50-475  
#17

50-476  
#18

50-477  
#19

50-478  
#38/39

50-479  
#61/62

50-480  
#31L

50-481  
#33L

50-482  
#22

50-483  
#3/6  
Cleoid/  
Discoid

50-484  
#89/92  
Cleoid/  
Discoid



**GRACEY**



**50-485**  
(G 1/2)

**50-486**  
(G 3/4)

**70-34**  
(G 5/6)

**50-488**  
(G 7/8)

**50-489**  
(G 9/10)

**50-490**  
(G 11/12)

**50-491**  
(G 13/14)





# Curettes



## COLUMBIA

## McCALLS

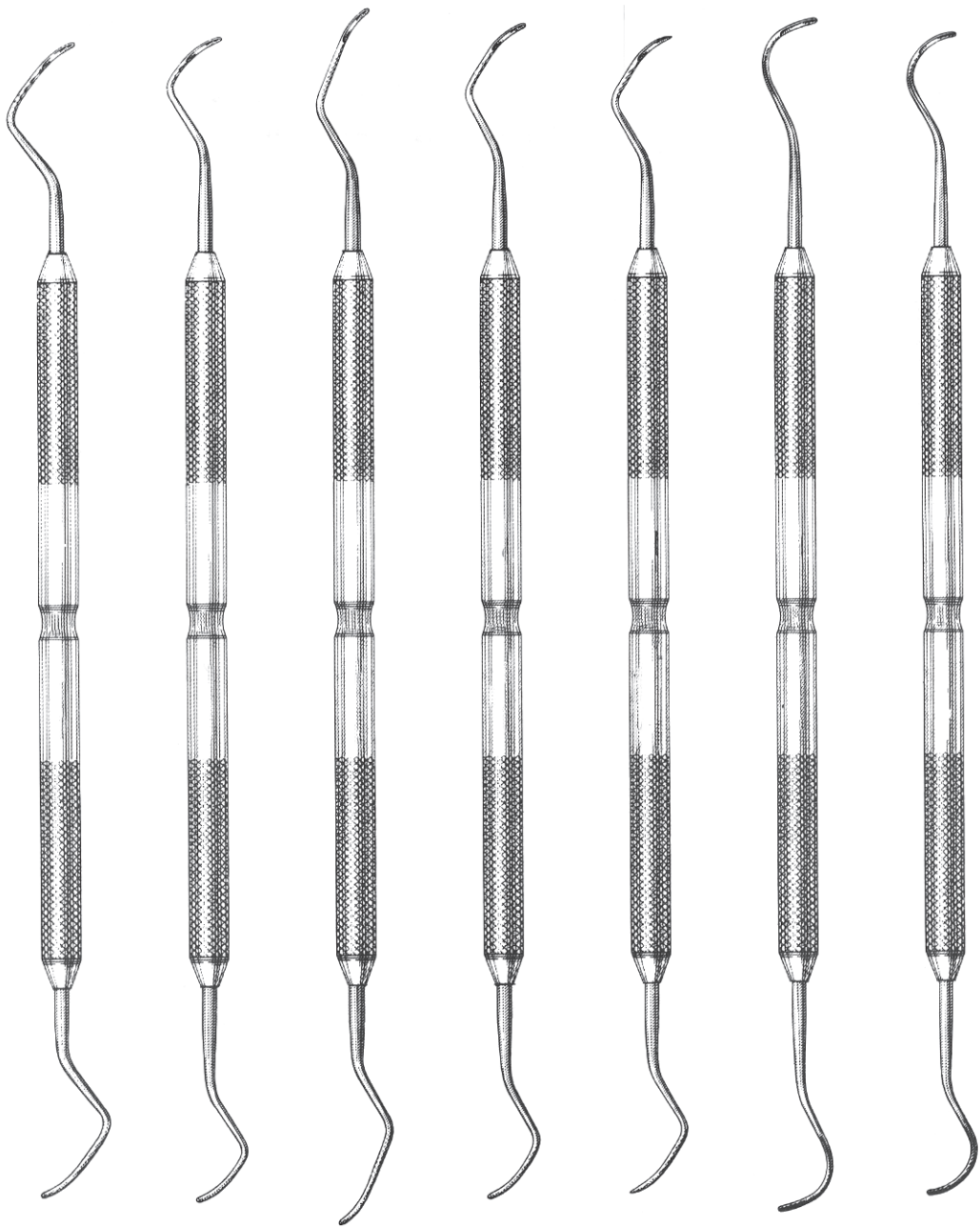
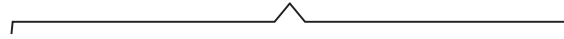

50-492  
(CO 4L/4R)

50-493  
(CO 13/14)

50-494  
(CO 2L/2R)

50-495  
(MC 13/14)

50-496  
(MC13S/14S)

50-497  
(MC 17/18)

50-498  
(MC 17S/18S)



# Curettes



## GOLDMAN-FOX

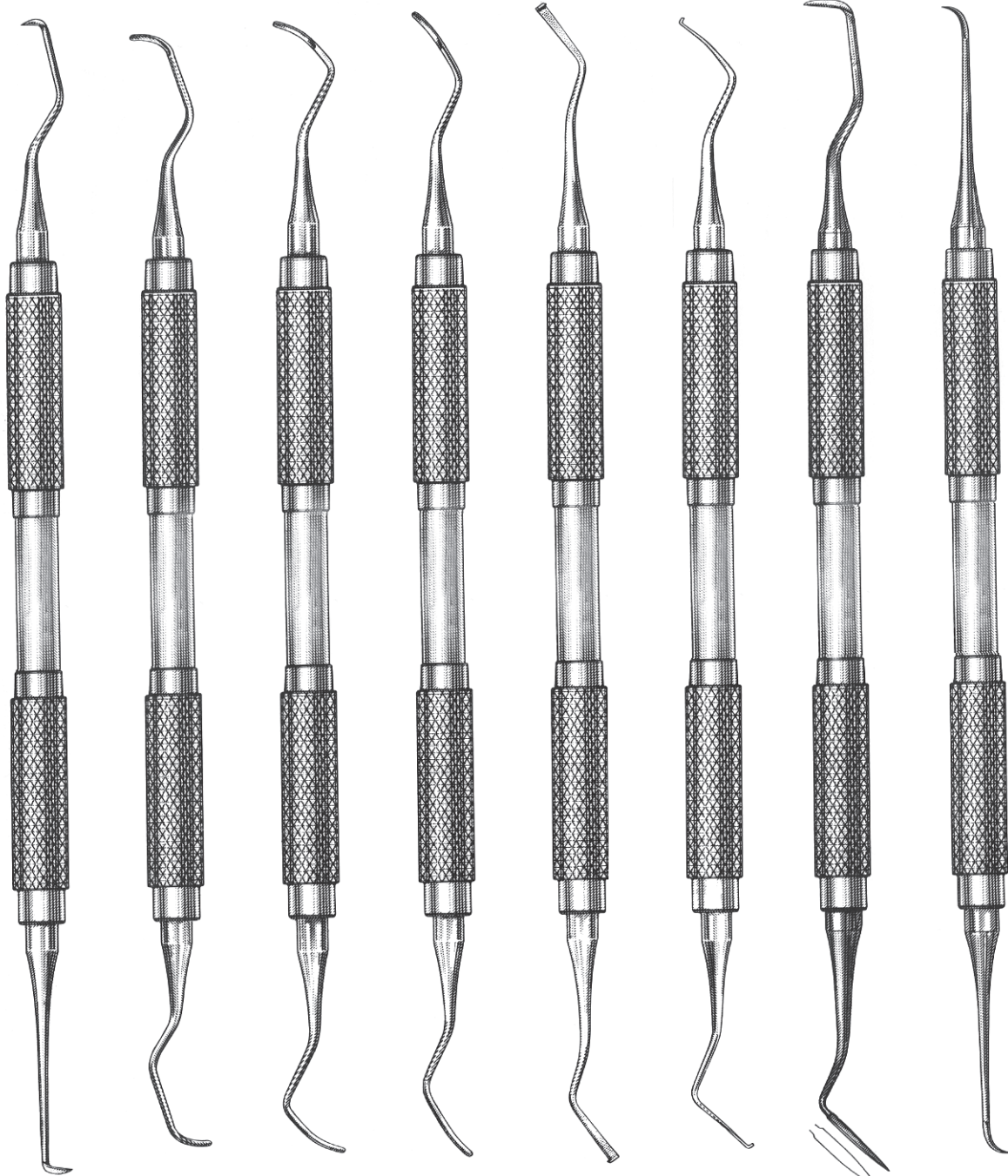

**50-499**  
Universal  
Scaler  
(GF 1)

**50-500**  
Curette-  
Anterior  
and Premolar  
(GF 2)

**50-501**  
Curette-  
Posterior  
(GF 3)

**50-502**  
Curette-  
Molar  
(GF 4)

**50-503**  
Scalar  
(GF 5)

**50-504**  
Scalar  
(GF 6)

**50-505**  
Knife/Scaler  
(GF 9)

**50-506**  
Curette  
(GF 12)



# Scalers

## JACQUETTE

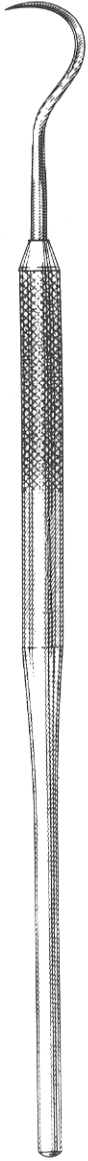

**50-507**  
(U-15)

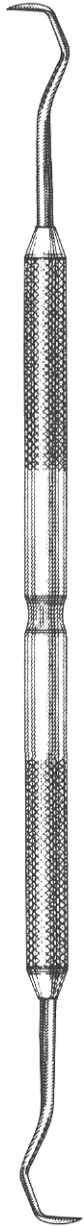

**50-508**  
(JAC 1Y/1Y)

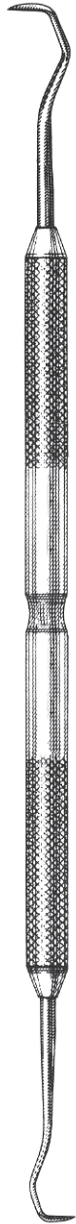

**50-509**  
(JAC 1Y/1YS)

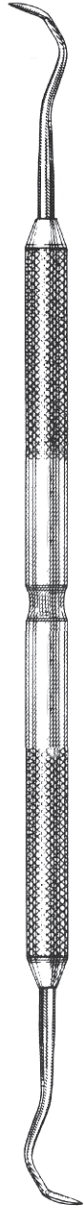

**50-510**  
(JAC 2Y/3Y)

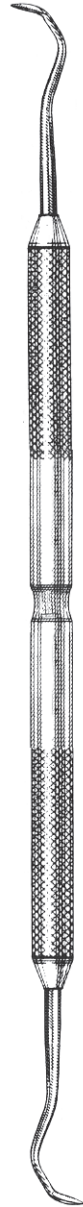

**50-511**  
(JAC 2YS/3YS)

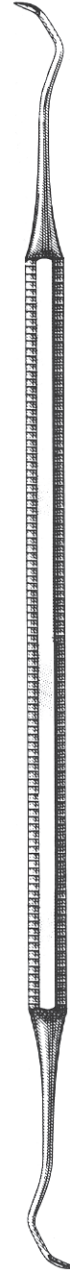

**50-512**  
(JAC 2/3)

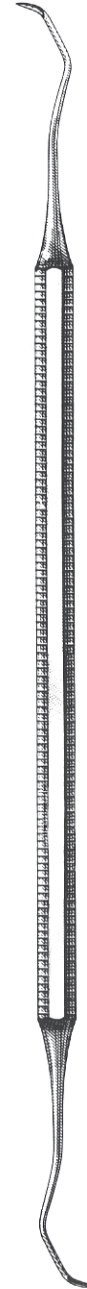

**50-513**  
(JAC 2S/3S)

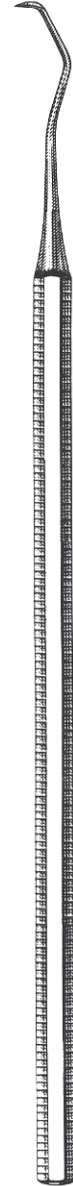

**50-514**  
(JAC 1)



# Scalers

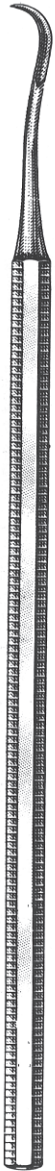

50-515  
#3



50-516  
#12

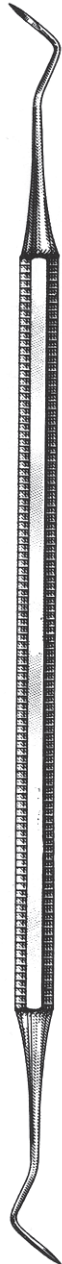

50-517  
#204S

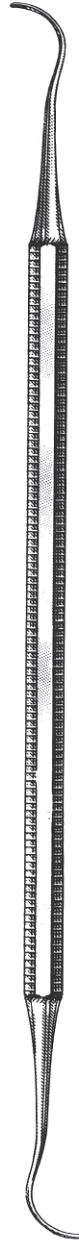

50-518  
Younger  
7/8

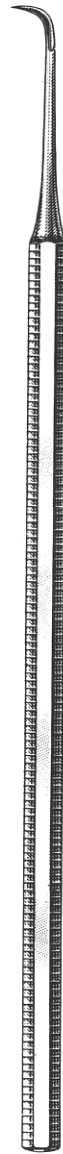

50-519  
Whiteside  
1-0



50-520  
Whiteside  
2-0

# Scalers

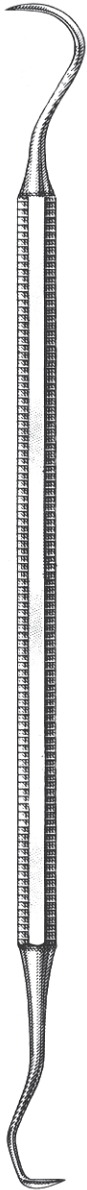

**50-521**  
(U15/30)

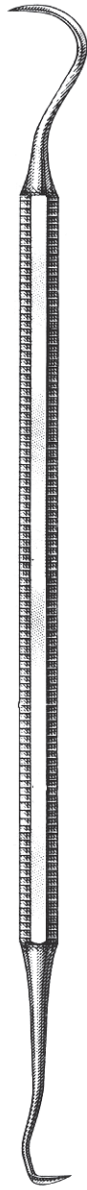

**50-522**  
(U15/33)

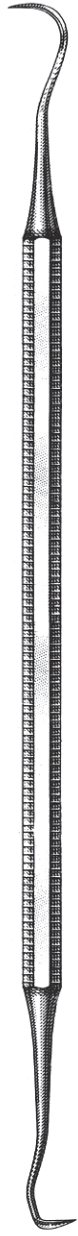

**50-523**  
(H 5/33)

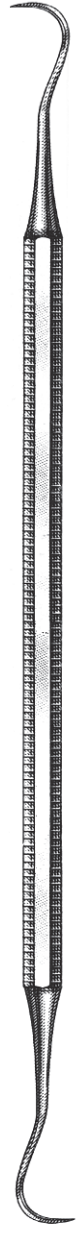

**50-524**  
(H 6/7)

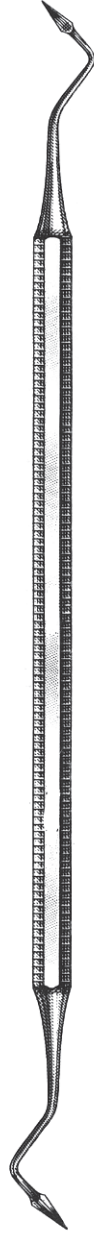

**50-525**  
(TA 2/3)

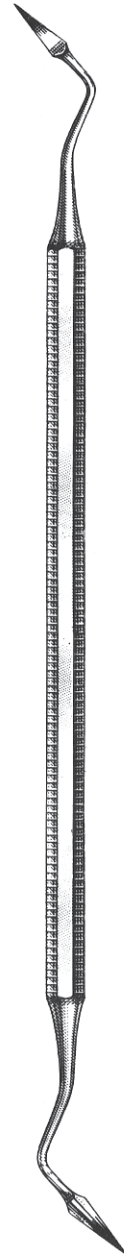

**50-526**  
(CK 6)



# Periodontal



## GOLDMAN-FOX

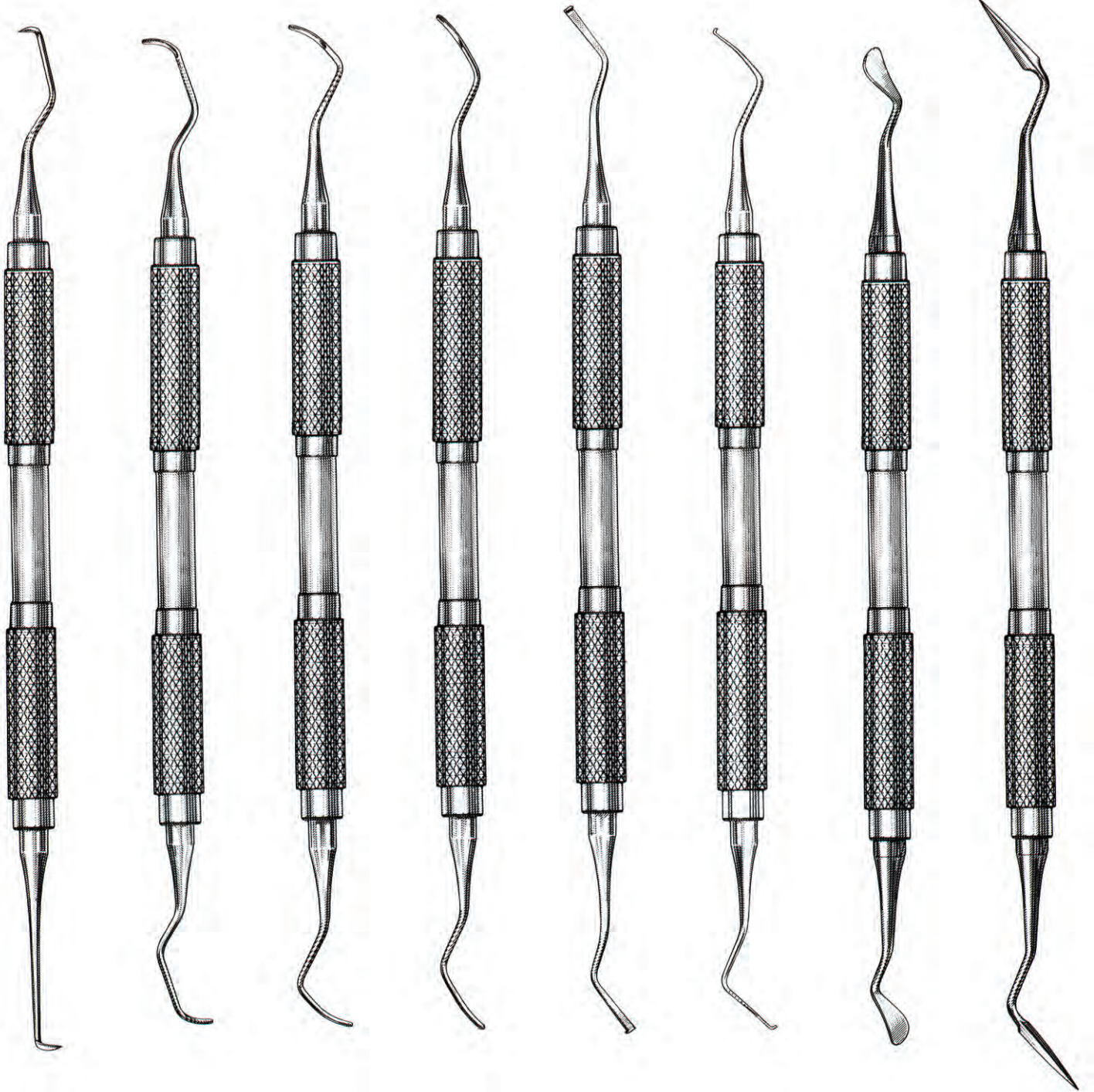

**50-527**  
Universal  
Scaler

**50-528**  
Curette-  
Anterior  
and Premolar

**50-529**  
Curette-  
Posterior

**50-530**  
Curette-  
Molar

**50-531**  
Scaler

**50-532**  
Scaler

**50-533**  
Knife

**50-534**  
Spear  
Knife



# Periodontal

## GOLDMAN-FOX



**50-535**  
Knife/Scaler

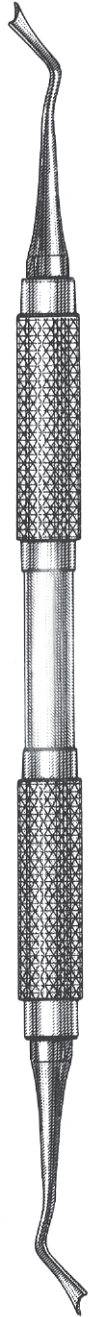

**50-536**  
Tissue Retractor

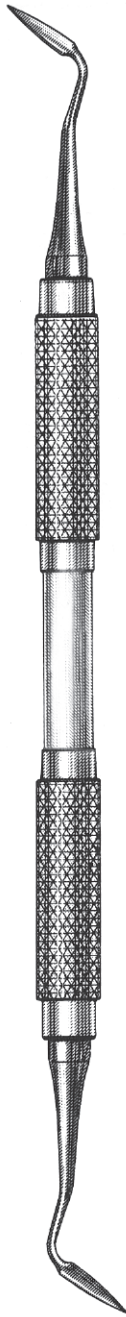

**50-537**  
Spear  
Knife



**50-538**  
Curette



**50-539**  
Periosteal  
Elevator

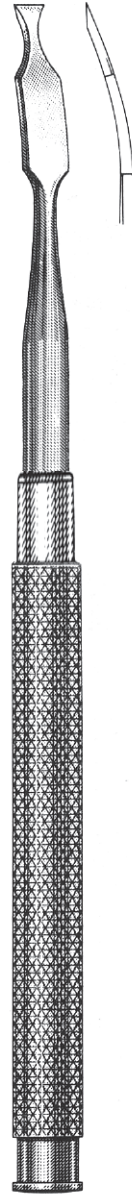

**50-540**  
OCHSENBEIN  
Chisel 1

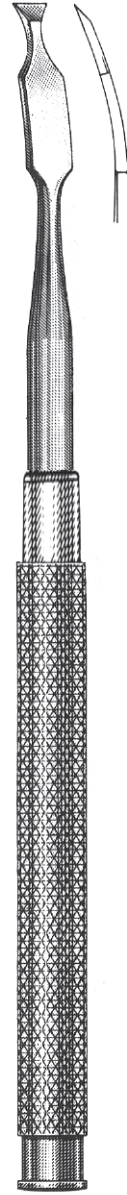

**50-541**  
OCHSENBEIN  
Chisel 2



**50-542**  
OCHSENBEIN  
Chisel 4



Periodontal

CRANE-KAPLAN



50-543  
ORBAN  
Knife 1-2

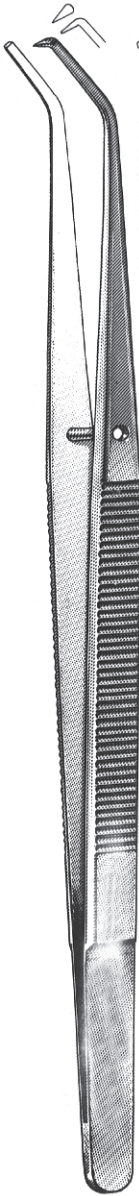

50-544  
Ck1  
Pocket  
Marker

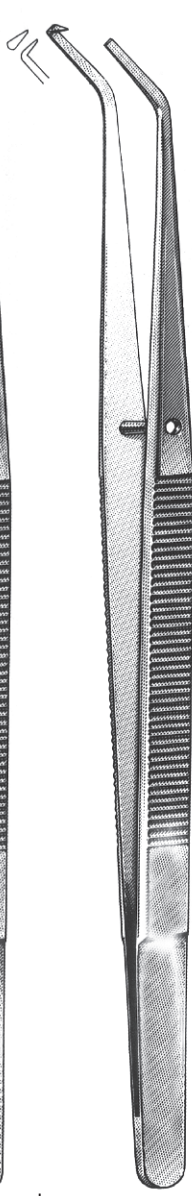

50-545  
Ck2  
Pocket  
Marker

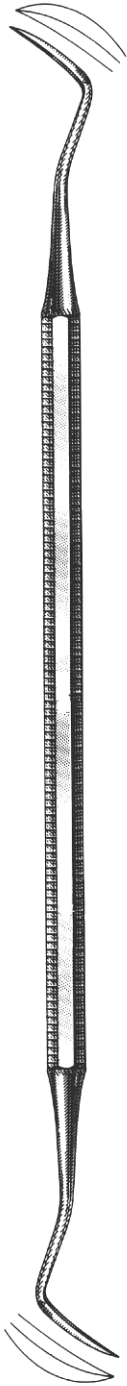

50-546  
Knife

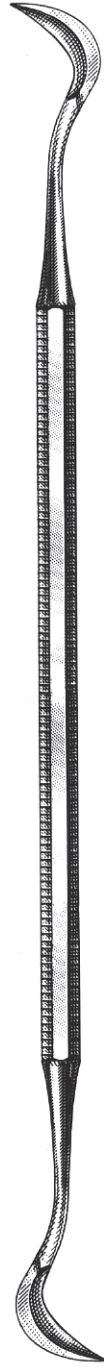

50-547  
Dissector

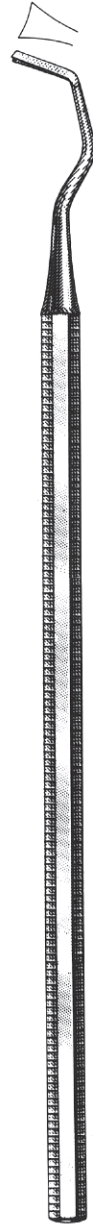

50-548  
Dissector

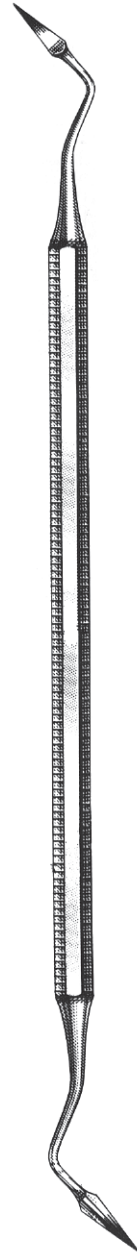

50-549  
Scaler

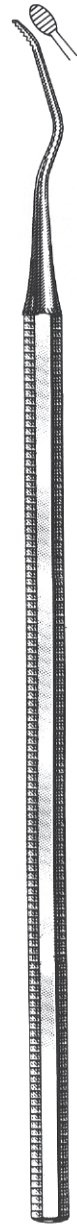

50-550  
File

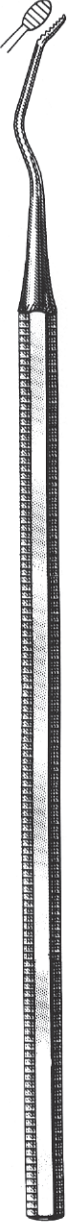

50-551  
File





# Periodontal



1/2



**50-552**  
Tissue Nipper, 5"



**50-553**  
Tissue Nipper, 4"

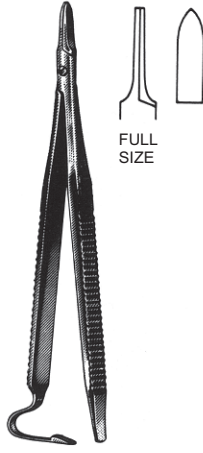

**50-554**  
Blade Breaker, 4 1/2"



**50-555**  
Blade Breaker, 5 1/4"



**50-556**  
Ross  
Self Locking  
Tissue Forceps, 6 1/4"



**50-557**  
Ross Perio  
Needle Holder, 5 1/2"



**50-558**  
Ross Perio  
Scissors, 4 3/4"



**50-559**  
**CASTROVIEJO**  
Perio Scissors, 3 1/2"

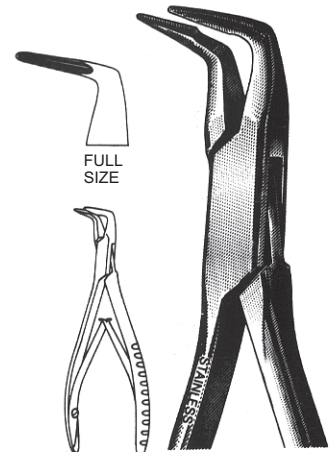

**50-560**  
**MICRO-FRIEDMEN**  
Perio Rongeur, 5 1/2"



# Periodontal

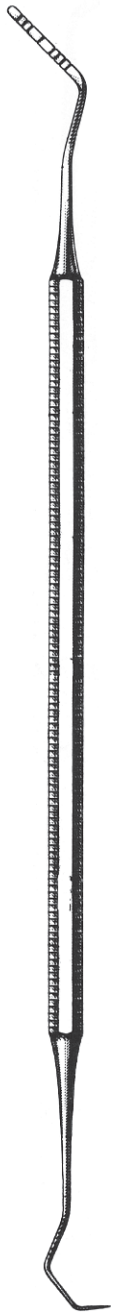

**50-561**  
Probe/Explorer  
(GF 17)

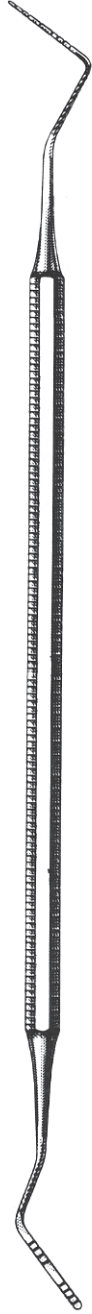

**50-562**  
Probe  
(GF 18)

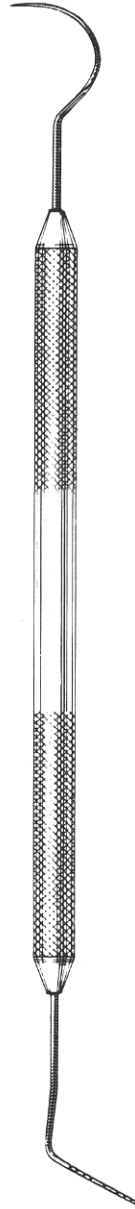

**50-563**  
Probe/Explorer  
(PE 1-23)

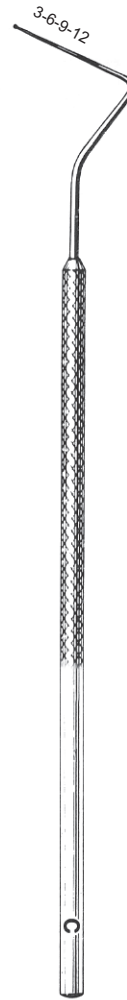

**50-564**  
Probe  
(C)

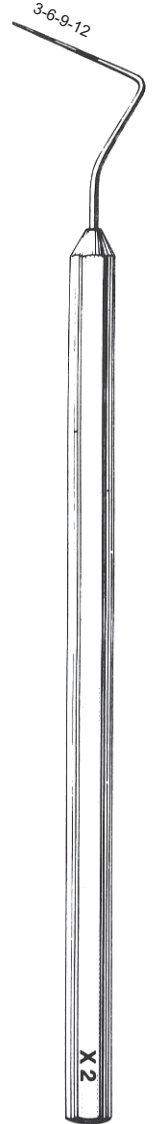

**50-565**  
Probe  
(X2)



# Plastic Filling Instruments

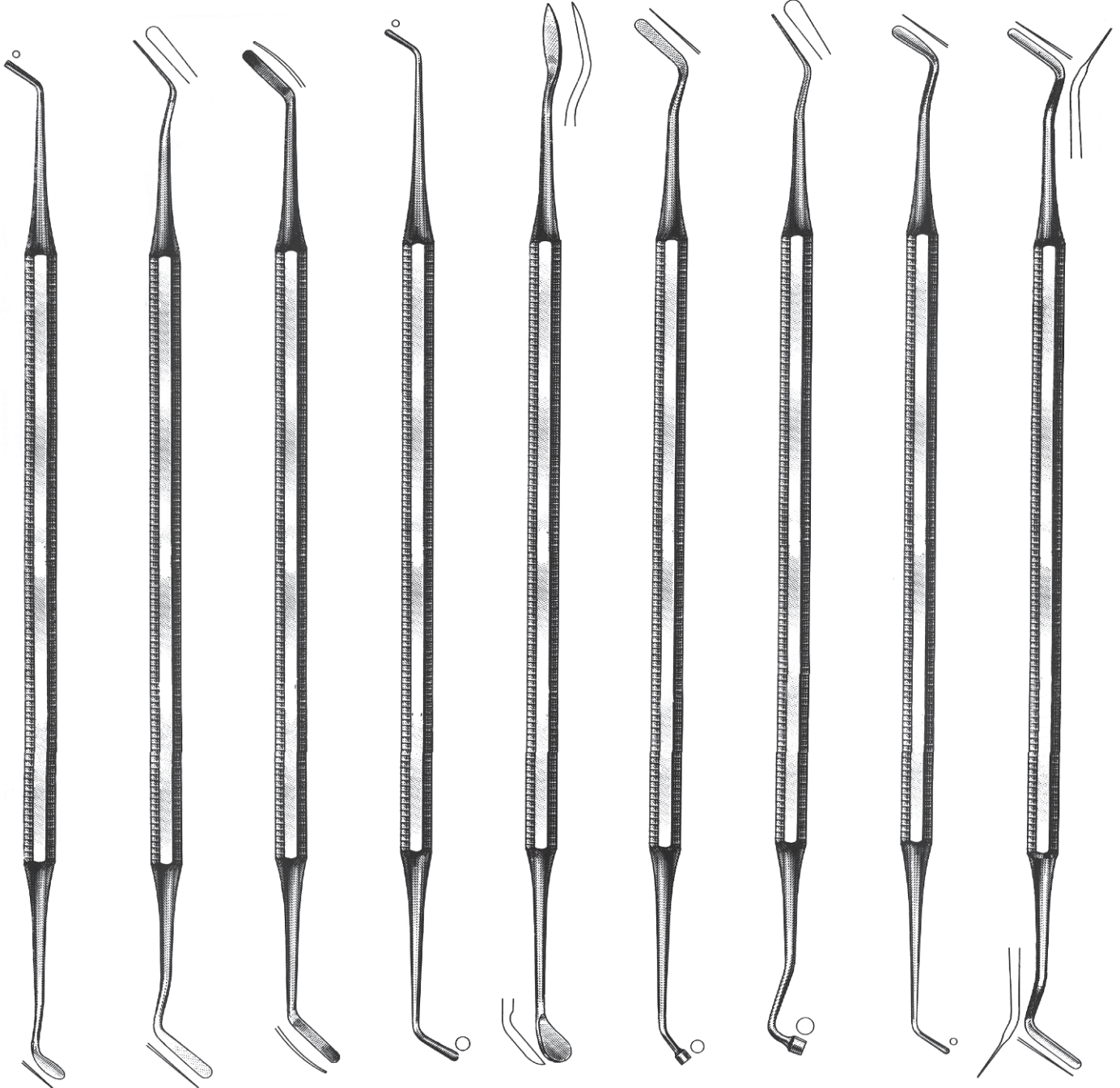

**50-566**  
(PF 3)

**50-567**  
(PF 4)

**50-568**  
(PF 5)

**50-569**  
(LAD 3)

**50-570**  
(WDS 1)

**50-571**  
(WDS 2)

**50-572**  
(WDS 3)

**50-573**  
(PF W3)

**50-574**  
(PF G 4/5)



# Burnishers, Amalgam Pluggers



## AMALGAM PLUGGERS

## BURNISHERS

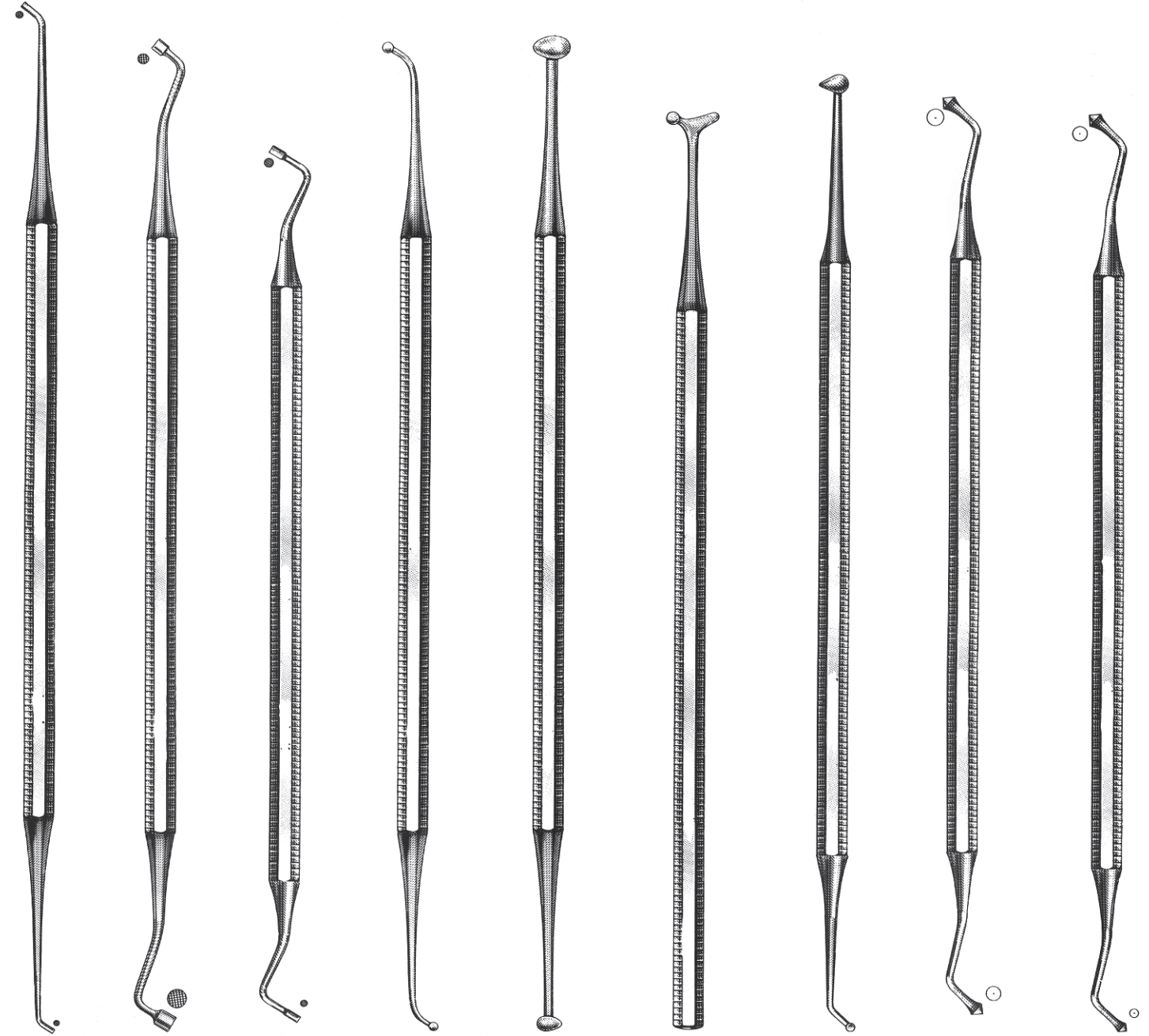

**51-575**  
BEHRMAN  
(APB 1)

**51-576**  
BLACK  
(APBL 1-2)

**51-577**  
MARQUETTE  
(MAR 0/1)

**51-578**  
(BURN 1)

**51-579**  
(BURN 28-29)

**51-580**  
(BURN 34)

**51-581**  
(BURN 27/29)

**51-582**  
(BURN 21B)

**51-583**  
(BURN 21)



# Amalgam Carriers



SIZE 1/2



**MEDIUM**  
52-586



**LARGE**  
52-588

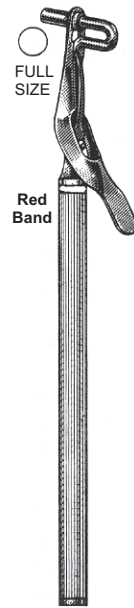

**JUMBO**  
52-590

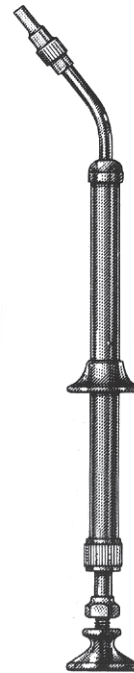

**52-592**  
NYLON TIP  
and Plunger

STAINLESS BARRELS  
DELTRIN BARRELS

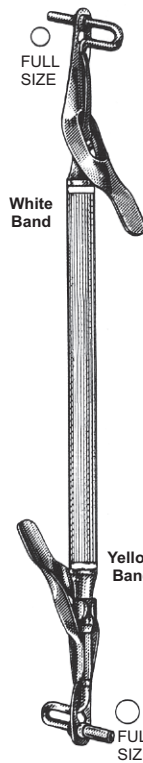

**MEDIUM/LARGE**  
52-593

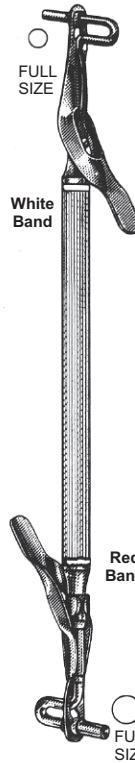

**MEDIUM/JUMBO**  
52-595

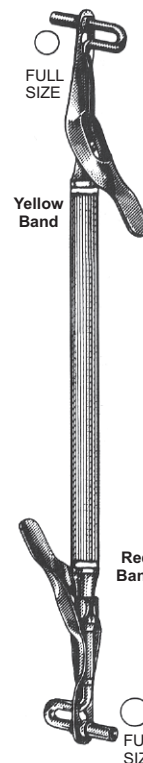

**LARGE/JUMBO**  
52-597

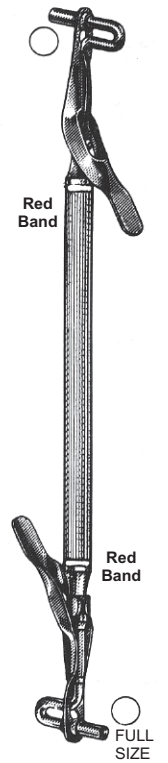

**JUMBO/JUMBO**  
52-599

STAINLESS BARRELS  
DELTRIN BARRELS



# Crown Gripper, Crown Remover



**51-584**  
WYNMAN CROWN GRI  
T-CARBIDE JAWS



**51-585A**



**1- 51-586B**



**51-587C**

**51-585 MORREL** Crown  
Remover Complete with A, B and C  
3 points- A, B and C  
**51-585A** Point A only  
**51-585B** Point B only  
**51-585C** Point C only



# Matrix Retainers and Bands, Strip Holder ( )

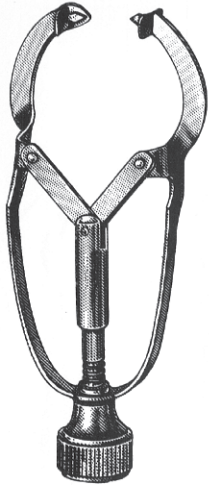

**53-602**  
#1

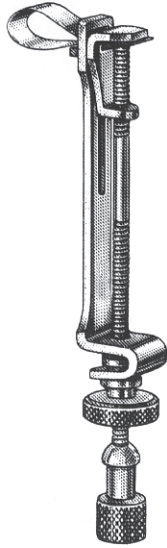

**53-603**  
#8

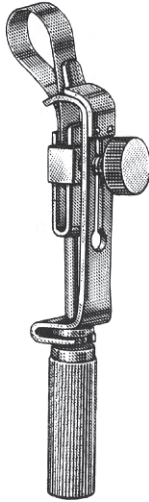

**53-604**  
#9

## "TOFFLEMIRE" TYPE



**53-605**  
JUNIOR

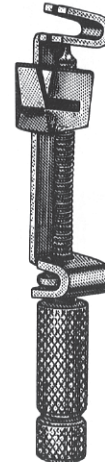

**53-606**  
SENIOR

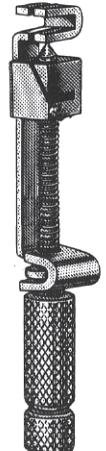

**53-607**  
UNIVERSAL

## TOFFLEMIRE BAN



.0015"      **53-608**  
.002"      **53-609**



.0015"      **53-610**  
.002"      **53-611**

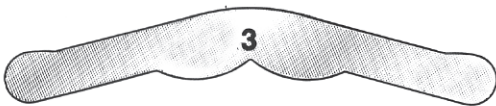

.0015"      **53-612**  
.002"      **53-613**

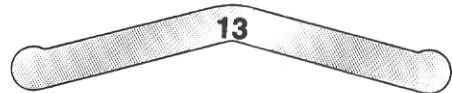

.0015"      **53-614**  
.002"      **53-615**

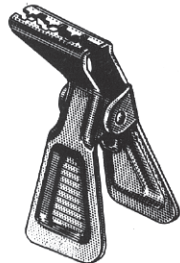

**53-616**  
Strip Holder  
Clip, 90°

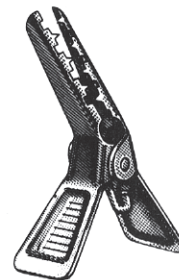

**53-617**  
Strip Holder  
Clip, 45°



# Wax Instruments



## COMFORT GRIP VINYL-COVERED INSULATING HANDLES



54-618 ROACH-A    54-619 ROACH-B    54-620 LECRON 5-A    54-621 LECRON 5-B    54-622 VEHE-A    54-623 VEHE-B    54-624 A7    54-625 B7    54-626 WARD 2-A    54-627 WARD 2-B

54-618S Set of 10 Comfort Grip Instruments





# Wax Instruments

P. K. THOMAS

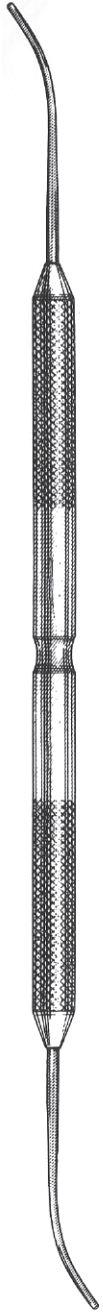

54-628

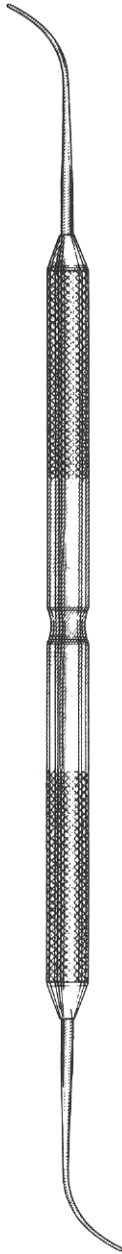

54-629

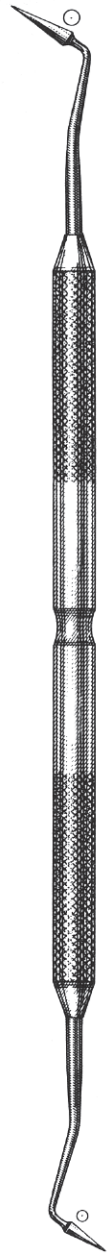

54-630

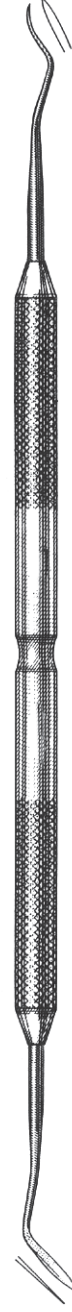

54-631

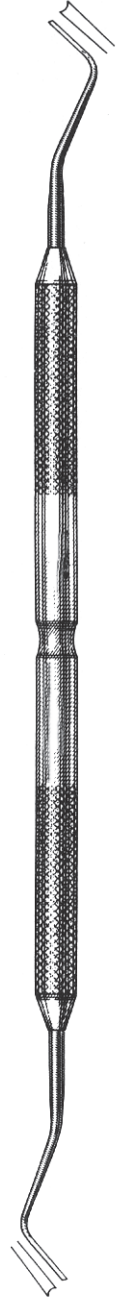

54-632

54-628S Set of 5 Instruments



# Wax Carvers

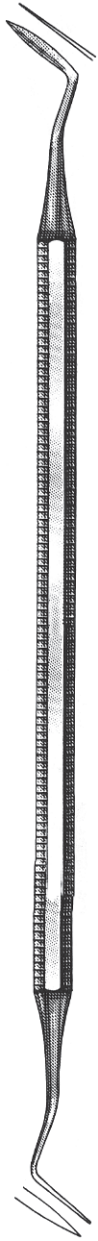

**54-633**  
HOLLENBACK  
3

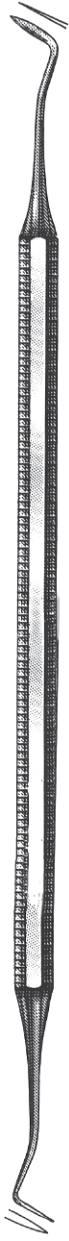

**54-634**  
HOLLENBACK  
3S

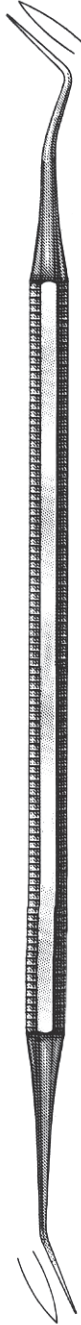

**54-635**  
WARD  
1

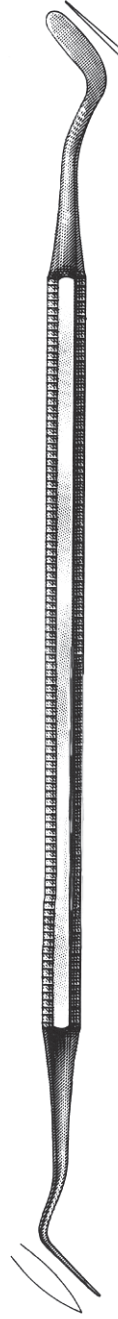

**54-636**  
WARD

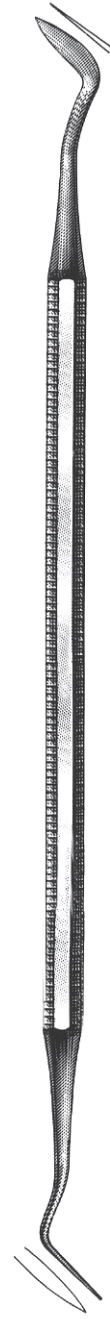

**54-637**  
WALL  
1

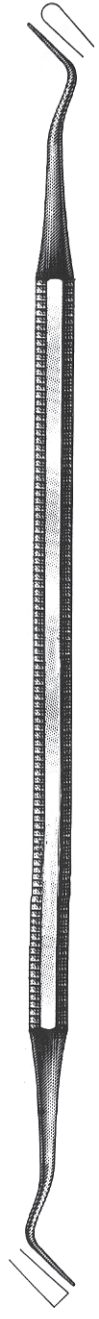

**54-638**  
WALL  
3



# Wax and Porcelain Carvers



**54-639**  
LECRON  
Inlay

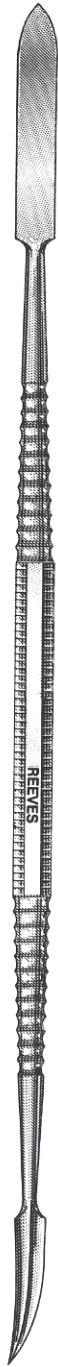

**54-640**  
REEVES

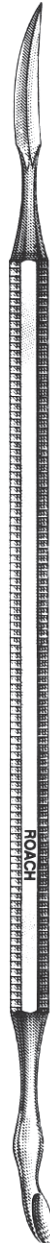

**54-641**  
ROACH  
WAX

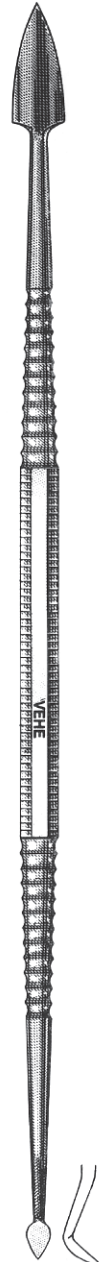

**54-642**  
VEHE  
Wax

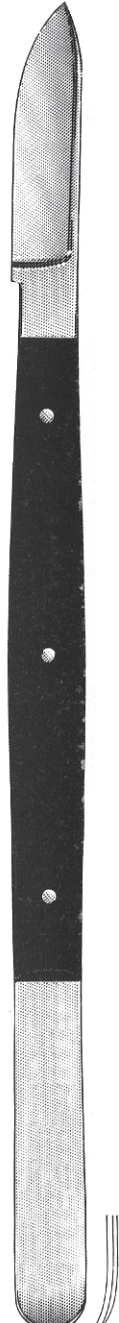

**54-643**  
FAHNENSTOCK 5"  
**54-644**  
FAHNENSTOCK 6 3/4"



# Wax Spatulas

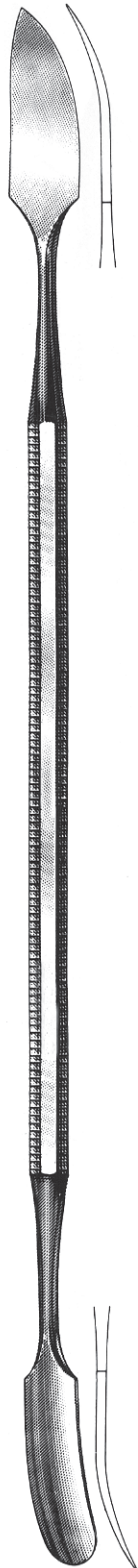

54-645



54-646

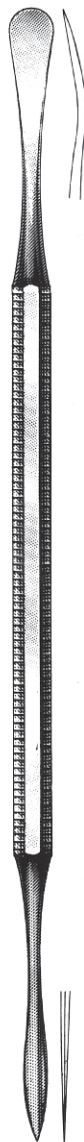

54-647

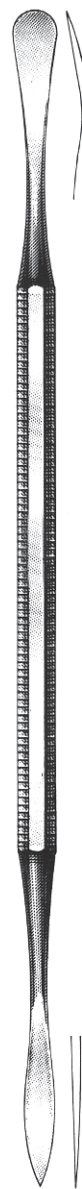

54-648  
Small end  
with one flat  
side

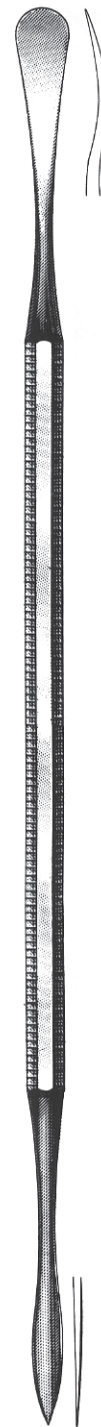

54-649



# Cement Spatulas

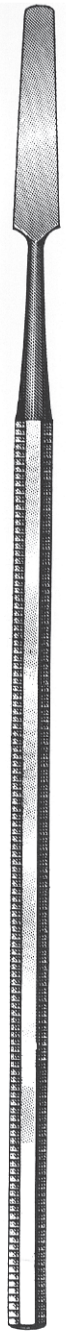

54-650

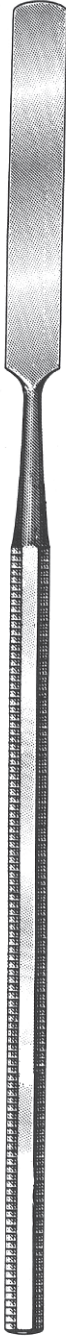

54-651  
Flexible

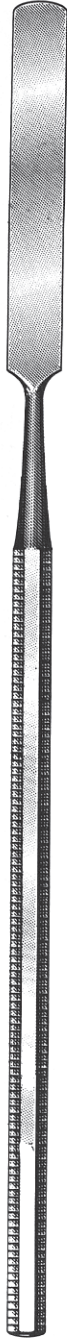

54-652  
Rigid



54-653

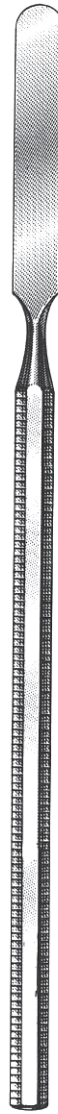

54-654

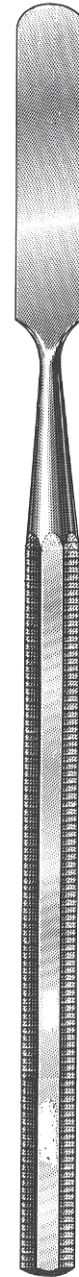

54-655

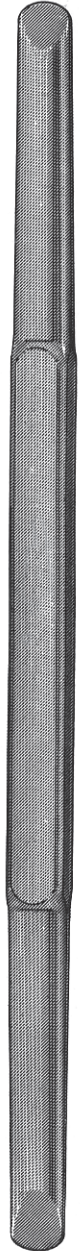

54-656  
AGATHE



# Miscellaneous Laboratory Instruments

## Platinum Foil Holding Forceps (All shown full size)



**55-657**  
Narrow, Fine,  
4 3/4"

**55-658**  
Super Fine  
4 3/8"

**55-659**  
Fine Curved  
4 1/2"

1/2



**55-660**  
ALL-PURPOSE Scissors  
7 1/2"



**55-665**  
Furnace Tongs, 10"  
**55-666**  
Furnace Tongs, 12"

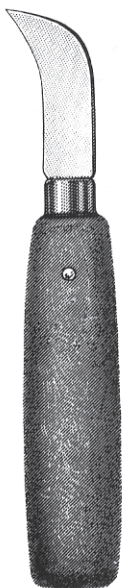

**55-661**  
MURPHY  
Plaster Knife

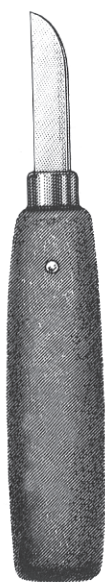

**55-662**  
Plaster and  
Compound Knife

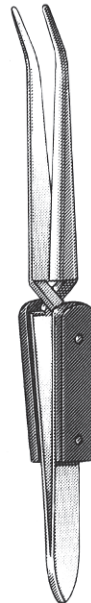

**55-663**  
Soldering Tweezers,  
6 1/4"

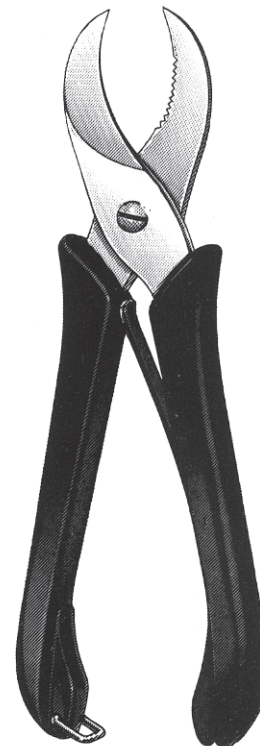

**55-664**  
Plaster Nipper 8" Stainless  
with Plastic Covered Handles



# Pliers

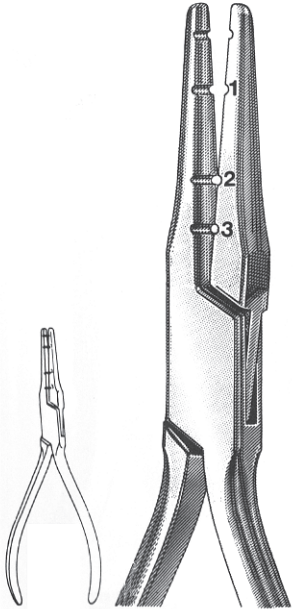

**56-667**  
101-Wire Bending

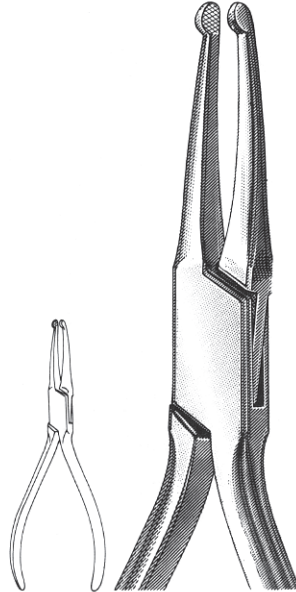

**56-668**  
110-HOW Crown, Str.

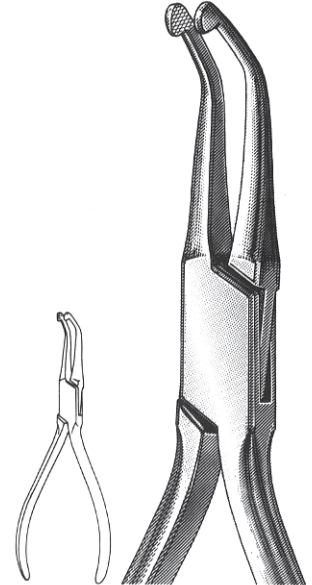

**56-669**  
111-HOW Crown, Curved

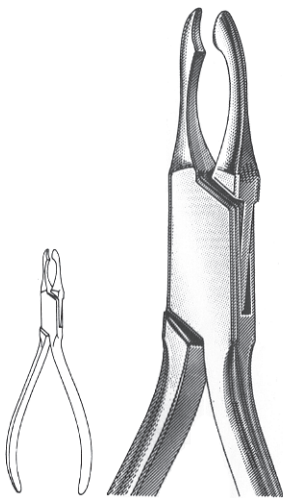

**56-670**  
114-JOHNSON, Contouring

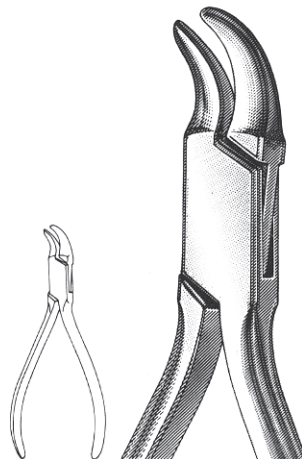

**56-671**  
115-REYNOLDS, Contouring

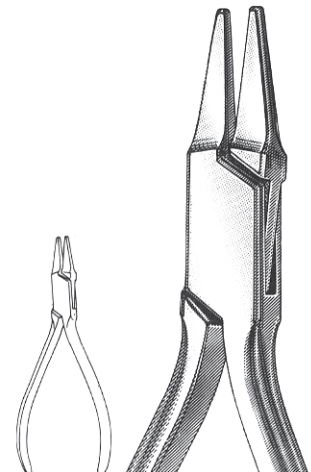

**56-672**  
118-PEESO, Collar



# Pliers

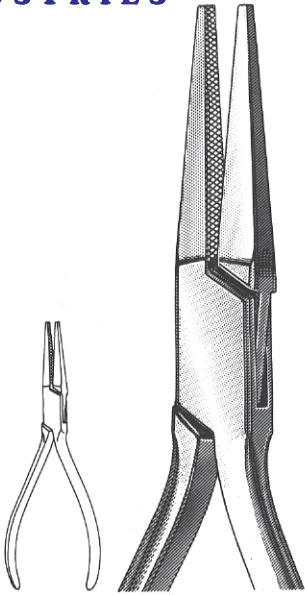
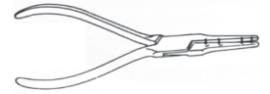

**56-673**  
121-LAB and Office

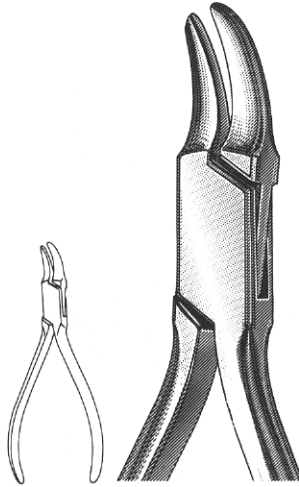

**56-674**  
137-GORDON, Contouring

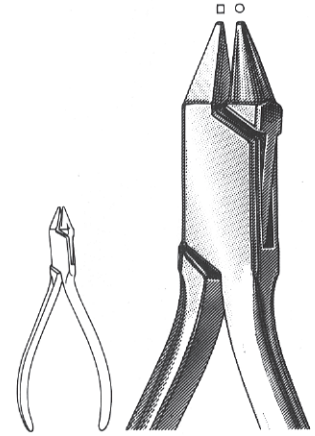

**56-675**  
139-Angle Wire Bending

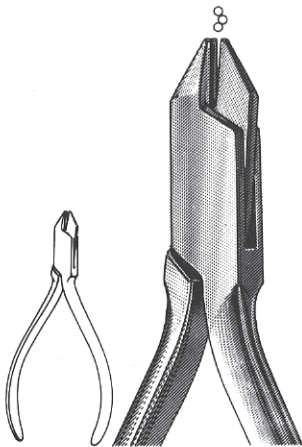

**56-676**  
200-Clasp Adjusting

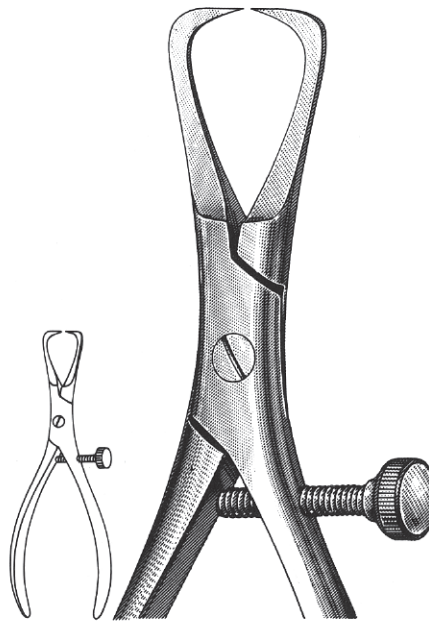

**56-677**  
255-BAADE, Band and Shell Removing

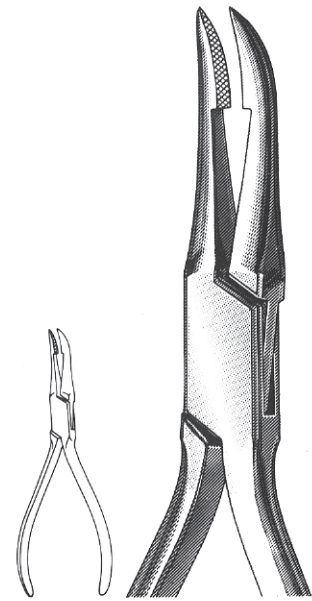

**56-678**  
861-WEINGART, Utility





# Pliers

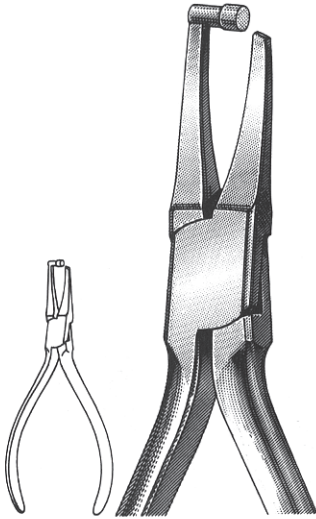
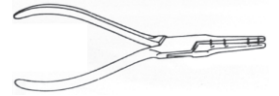

**56-679**  
347-OLIVER, Band Removing,  
Aluminum Tip

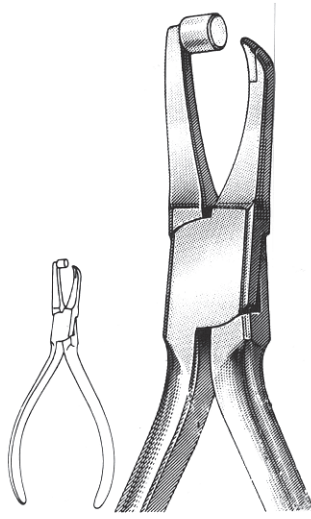

**56-680**  
347NTS-Nylon tip, Tool,  
Steel Insert Jaw

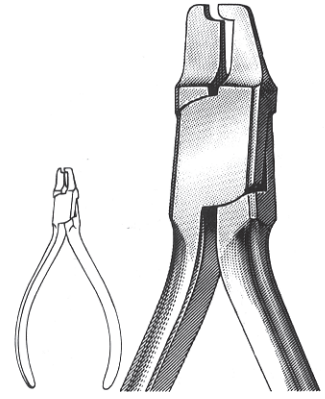

**56-681**  
417-Crown and Shell

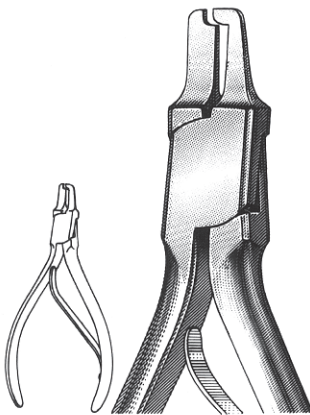

**56-682**  
421S-Primary Crown Crimping

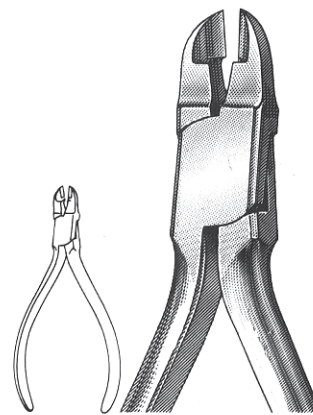

**56-683**  
150S-Carbide Tipped  
Ligature Cutter



# Orthodontic Instruments Omitt

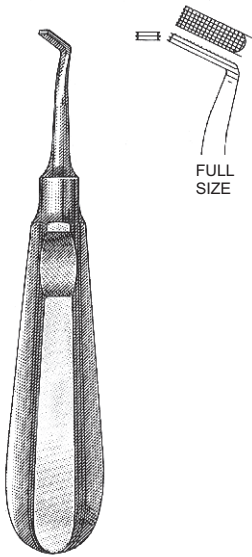
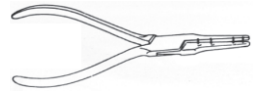

**57-687**  
300X-One Piece  
Construction Band  
Pusher

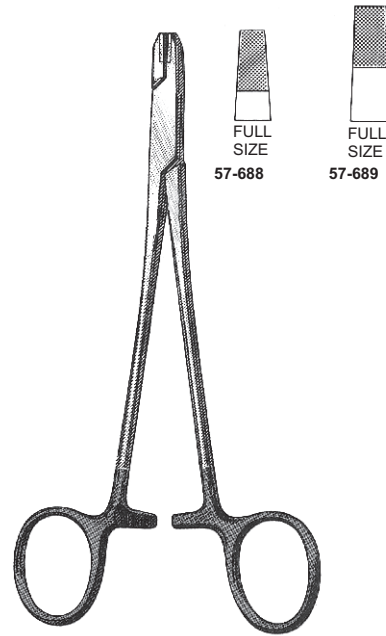

**57-688**  
Wire Twister 6" , with T-Carbide  
Jaws

**57-689**  
Wire Twister 8" , with T-Carbide  
Jaws



# Endo Forceps



1/2



**57-694**  
STIEGLITZ  
Fragment Forceps,  
4 3/4" , 90

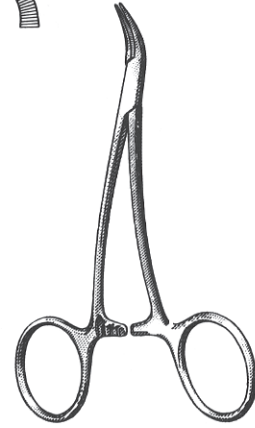
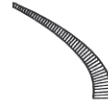

**66-696**  
PEETS Forceps, 4 3/4" ,  
useful for removing  
broken instruments



**66-695**  
Silver Point  
Holding Forceps, 4 3/4"



**66-697**  
Self-locking  
Silver Point  
Holding Forceps, 6"

Instruments shown 1/2 size



# Articulating Paper Forceps, Rubbers Dam P

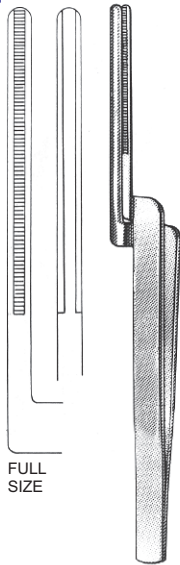

**58-698**  
POSIGRIP Articulating  
Papers Forceps

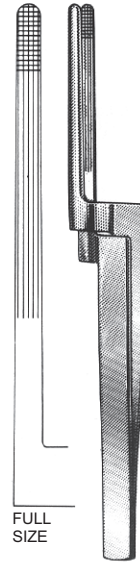

**58-699**  
Standard Articulating  
Paper Forceps, Economy Grade

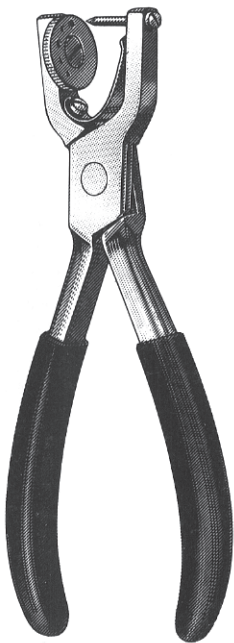

**58-700**  
AINSWORTH Type Rubber  
Dam Punch

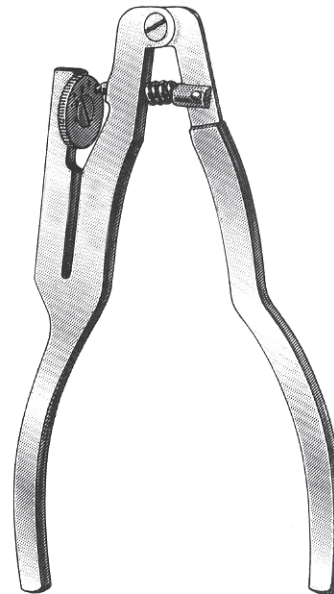

**58-701**  
Lightweight Rubber  
Dam Punch

Instruments shown 1/2 size



# Rubber Dam Clamp Forceps and Holder

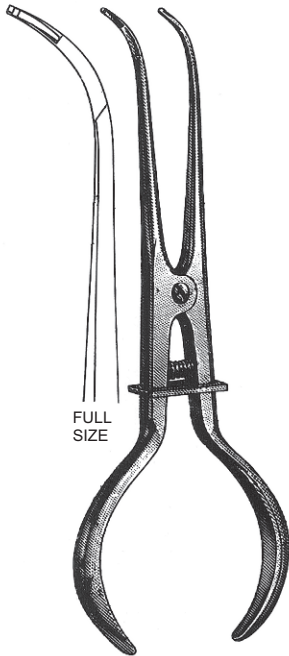

**58-702**  
U. Of Washington Pattern.  
Rubber Dam Clamp Forceps

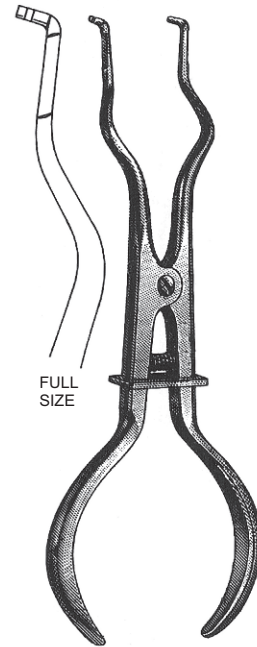

**58-703**  
Brewer Rubber  
Dam Clamp Forceps

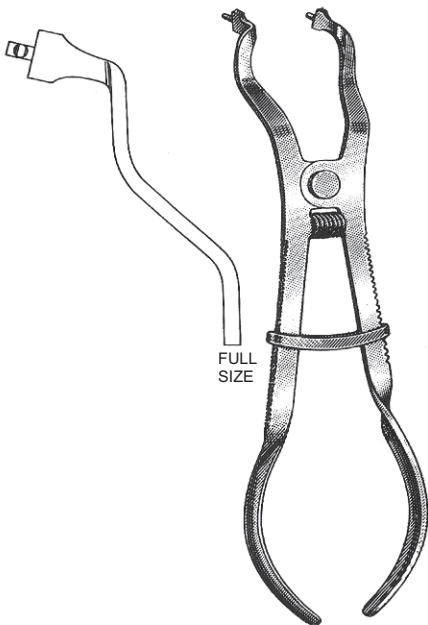

**58-704**  
Lightweight Rubber  
Dam Clamp Forceps

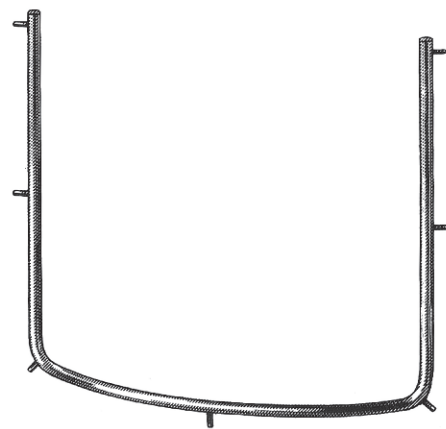

**58-705**  
Rubber Dam Holder,  
Stainless Pins

Instruments shown 1/2 size



## Scalpel Handles



**59-706**  
**59-706A**



**59-707**



**59-708**



**59-709**

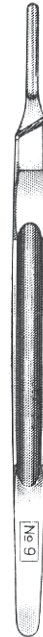

**59-710**



**59-711**  
**SIEGEL**

**59-706**

KNIFE HANDLE No. 3 fitting surgical blades Nos. 10 thru 15, Extra Fine Stainless

**59-706A**

Same as No. 4-7, but Economy Grade, Rustless, Nickle Plated

**59-707**

KNIFE HANDLE No. 7, fitting surgical blades Nos. 10 thru 15, Extra fine Stainless

**59-708**

KNIFE HANDLE No. 3L, for deep surgery, fitting blades Nos. 10 thru Extra Fine, Stainless

**59-709**

KNIFE HANDLE No. 3LA, angled tip, for deep surgery, fitting blades 10 thru 15, Extra Fine, Stainless

**59-710**

Knife Handle No.9, fitting blades No.10 thru 15 Extra fine stainless

**59-711**

SIEGEL ROUND KNIFE HANDLE, fitting blades Nos. 10 thru 15, Extra Stainless



# Scalpel Handles

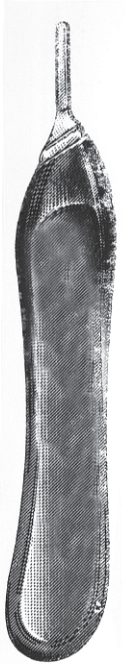

**59-712**  
**59-712A**



**59-713**

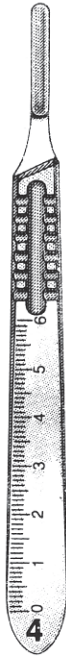

**59-714**  
**59-714A**

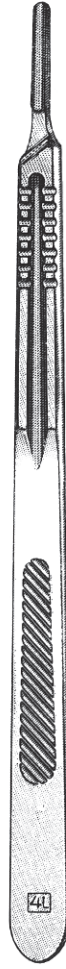

**59-715**



**59-716**



**59-717**

**59-712**

KNIFE HANDLE No. 5 fitting surgical blades Nos. 10 thru 15, Extra Fine, Plastic

**59-713**

E-Z OFF (Pat. Pend.) KNIFE HANDLE No. 3, fitting surgical blades Nos. 10 thru Autoclavable, Plastic

**59-714**

KNIFE HANDLE No. 4 Fitting surgical blades 20 through 25, Extra fine stainless

**59-714A**

Same as No. 59-714, but Economy Grade, Rustless, Nickle Plate, has mm and cm graduations

**59-715**

KNIFE HANDLE No. 4L, for deep surgery, fitting blades Nos. 20 thru 25, Extra Fine, Stainless

**59-716**

KNIFE HANDLE No. 6 fitting surgical blades Nos. 20 thru 25, Extra Fine, Red Plastic

**59-717** knife handle No.4, fitting blades Nos.20 thru 25 Autoclavable, plastic.



# Mucocele Forceps Suction Tubes

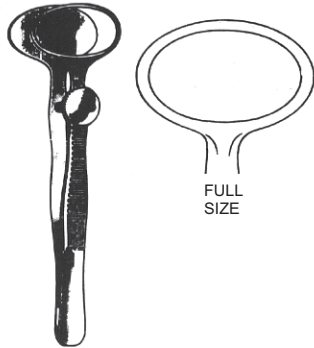

**59-718**  
**MUCOCELE FORCEPS**  
 Fixate, isolate and act as a haemostat, allowing a clear field, thus facilitating surgery. Side ring measures 12x23 mm

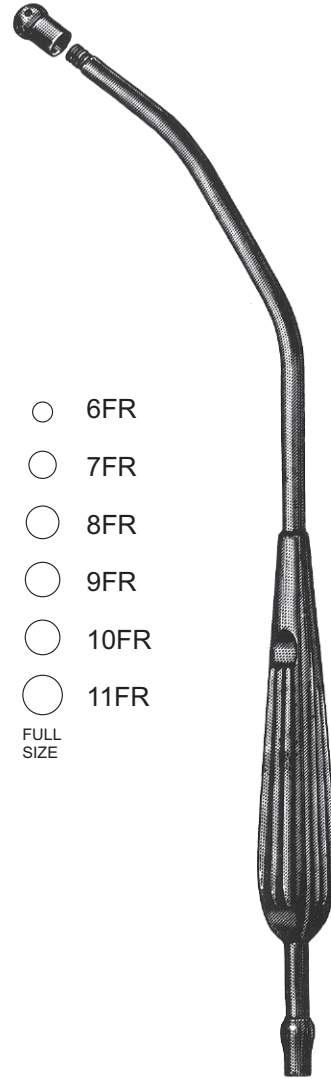

- 6FR
- 7FR
- 8FR
- 9FR
- 10FR
- 11FR
- FULL SIZE

**59-719**  
**YANKAUER SUCTION TUBE**  
 11 3/4"  
**59-720**  
**CHROME**  
 Stainless





## Alphabetical Index

### A

Adson Dressing Forcep	46
Adson Tissue Forcep	45
Agatha Cement Spatula	85
All-purpose Scissors	86
Allis Tissue Forceps	45
Amalgam Carriers	77
Amalgam Pluggers	76
Amalgam Well	77
Andrew Tongue Depressor	35
Angle Wire Bending Pliers	88
Articulating Paper Forceps	94

### B

Backhaus Towel Clump	48
Band Bushers	91
Bandage Scissor	41
Baumgartner Needle Holder	52
Behrman Amalgam Pluggers	76
Beyer Rongeur	27
Black Amalgam Plugger	76
Blade Breakers	73
Blumenthal Rongeurs	24
Boley Gauge	59
Bone Chisels	31
Bone Curetters	28
Bone Files	29
Bone Holding Forceps	33
Bone Mallets	32
Bone Rongeur	27
Boynton Needle Holder	51
Brown Tissue Forceps	45
Buckley Bone Chisel	31
Burnishers	76

### C

Castroviejo Gum Scissors	41,73
Castroviejo Needle Holders	54
Cement Spatulas	85
Cheek Retractors	34
Chisels, Bone	31
Chisels, Periodontal	71
Clamps, Towel	48
Clasp Adjusting Plier	88
Clips, Strip Holder	79
Collar & Crown Scissors	44
College Pliers	57
Collier Needle Holder	50
Columbia Curettes	65
Columbia Lip Retractor	34
Compound Knife	86
Cotton And Dressing Pliers	57
Crane-kaplan Perio Instruments	72
Crile-wood Needle Holder	52-53
Crile Needle Holders	53

Crown & Shell Crimping Pliers	89
Crown Gauge	59
Crown Gripper	78
Crown Remover	78
Curettes	64-66
Curettes, Bone	28

### D

Davis Sterilizer Forceps	56
Dean Gum Scissors	37
Dehardt Mouth Gag	36
Depressors, Tongue	35
Deft Needle Holders	50
Dingman Bone Holding Forceps	33
Dividers	59
Dressing Forceps	46

### E

Elevators	20-23
Endo Forceps	93
Endo Instruments	92
Endo Sterilizer Cases	92
English Pattern Extracting Forceps	16
Excavators	63
Explorer-probes	62
Explorers	60-61
Extracting Forceps	5-19

### F

Fahnenstock Wax Carver And Knife	83
Fiberglass Mirrors	58
Files, Bone	29
Files, Periodontal	72
Forceps, Articulating Paper	94
Forceps, Bone Holding	33
Forceps, Dressing	46
Forceps, Endo	93
Forceps, Extracting	5-19
Forceps, Hemostatic	49
Forceps, Mucocele	98
Forceps, Platinum Foil Holding	86
Forceps, Root	14
Forceps, Rubber Dam Clamp	95
Forceps, Silver Point Holding	57,93
Forceps, Sterilizer	56
Forceps, Tissue	45
Forceps, Tongue Seizing	35
Frazier Tissue Hooks	47
Freer, Periosteal Elevator	23,71
Friedman Rongeurs	26
Furnace Tongs	46,86

### G

G-F Curettes	66
G-F Periodontal Instruments	37-70-71
G-F Gum Scissors	37
Gardner Bone Chisels	31
Gardner Needle Holder	51
Gauges	59



Gerzog Mallet	32
Gordon Contouring Plier	88
Gracey Curettes	64
Gregg Plastic Filling Instruments	75
Gum Scissors	37-41

## H

Halsey Needle Holders	50
Halstead Mosq. Forceps	49
Handles, Mirror	58
Handles, Scalpel	94-95
Hartman Rongeur	27
Heath Gum Scissors	37
Hemostatic Forceps	49
Holders, Needle	50-54
Hollenback Wax Carvers	82
Hooks, Tissues	47
How Crown Pliers	87
Howard Bone File	30

## I

Impression Trays	55-56
Inlay Carver	83
Instruments, Orthodontic	91
Iris Gum Scissors	38-39

## J

Jacquette Scalers	67
Johnson Contouring Pliers	87
Jones Towel Clamp	48
Joseph Gum Scissors	40

## K

Kelly Forceps	49
Kelly Gum Scissors	40
Kern Bone Holding Forceps	33
Knife, Compound	86
Knife, Orban Perio	72
Knives, Plaster	86
Knowles Bandage Scissors	41

## L

La Grange Gum Scissors	40
Ladmore Plastic Filling Instruments	75
LeCrony Inlay Carvers	80-83
Ligature Cutting Pliers	89
Lip Retractors	34
Lister Bandage Scissors	41
Littauer Suture Scissors	43
Locklin Gum Scissors	41
Long Suture Scissors	43
Lorna Towel Clamps	48
Lucas Bone Cerettes	28

## M

Mallets, Bone	32
Marquette Amalgam Plugger	76
Mathieu Needle Holders	51
Matrix Bands	79

Matrix Retainers	79
Matrix Scissors	44
Mayo-Hegar Needle Holders	52
Mayo Scissors	42
McCalls Curettes	65
Mead Bone Mallet	32
Mead Extracting Forceps	15
Mead Rongeurs	25
Meria Plier	57
Miller Bone Files	29
NS Bone Mallets	32
NS Lip Retractor	34
NS Tissue Fixator	47
Mirror Handles	58
Mirrors, Mouth	58
Molt Bone Curettes	28
Molt Mouth Gags	36
Molt Periosteal Elevator	23
Morrel Crown Remover	78
Mouth Gags	36
Mouth Mirrors	58
Mococele Forceps	98

## N

Napkin Holders	48
Needle Holder, Periodontal	73
Needle Holders	50-54
Neivert Needle Holder	50
Nipper, Plaster	86
Northbent Suture Scissors	43

## O

Ochsenbein Pero Chisels	71
Oliver Band Removing Pliers	93
Olsen-Hegar Needle Holders	51
Orban Perio Knife	72
Orthodontic Instruments	91
Orthodontic Wire	91

## P

P. K. Thomas Wax Instruments	81
Pedodontic Extracting Forceps	18-19
Peeso Collar Pliers	87
Peets Forceps	14-93
Periodontal Files	72
Periodontal Instruments	70-74
Periodontal Rongeur	73
Periosteal Elevators	23-71
Perry Pliers	57
Plaster Knives	86
Plaster Nipper	86
Plastic Filling Instruments	75
Pliers	87-89
Pliers, Cotton And Dressing	57
Pocket Markers, Perio	72
Polokoff Bone File	30
Porcelain Carvers	83
Potts Periosteal Elevators	23
Probes	62
Probes, Periodontal	62-74
Probes, Salivary Gland	98



<b>Q</b>	
Quimby Gum Scissor	37

<b>R</b>	
Reeves Wax Carver	83
Retraction Cord Cutting Scissors	43
Retractors, Cheek	34
Retractors, Tissue	47
Reynold Contouring Plier	87
Roach Wax Carvers	80,83
Rongeur, Periodontal	73
Rongeurs	24-27
Ross Gum Scissor	41-73
Ross Periodontal Instruments	73
Rubber Dam Clamp Forceps	95
Rubber Dam Holder	95
Rubber Dam Punches	94
Russian Tissue Forceps	45
Ryder Needle Holders	53

<b>S</b>	
Selivary Gland Probes	98
Scalers	67-69
Scalpel Handles	94-95
Scissors, All-purpose	86
Scissors, Bandage	41
Scissors, Collar & Crown	44
Scissors, Gum	37-46
Scissors, Periodontal	37-41-73
Scissors, Retraction Cord	43
Scissors, Surgical	42
Scissors, Suture	43
Scissors, Wire Cutting	44
Seldin Periosteal Elevator	23
Self-locking Pliers	57,93
Semkin Dressing Forcep	46
Semkin Tissue Forceps	45
Senn Tissue Retractor	47
Shortbent Suture Scissors	43
Silver Point Holding Forceps	57-93
Soldering Tweezers	86
Spatulas, Cement	85
Spatulas, Wax	84
Spencer Suture Scissors	43
Splinter Forceps	14,93
Stevens Needle Holder	54
Stieglitz Forceps	14-93
Strip Holder Clips	79
Suction Tubes	98
Sullivan Gum Scissors	40
Surgical Scissors	42
Suture Scissors	43
Suture Wire	91

<b>T</b>	
Taylor Scaler	69
Tissue Forceps	45-73
Tissue Forceps, Periodontal	47-73
Tissue Hooks	47
Tissue Nippers	73
Tissue Retractors	47
Tofflemire Type Band	79
Tofflemire Type Retaines	79
Tongue Depressors	35
Tongue Seizing Forceps	35
Towel Clamps	53
Tweezers, Soldering	86

<b>U</b>	
U Of Minnesota Cheek Retractor	34
Utility Sterilizer Forceps	56

<b>V</b>	
Vehe Wax Carvers	80,83

<b>W</b>	
Wagner Gum Scissors	39
Wakefield Bone Chisels	31
Wall Wax Carvers	82
Ward Wax Carvers	80,82
Wax Instruments	80-83
Wax Spatulas	84
Wabster Tongue Depressor	50,53
Weingart Utility Pliers	88
West Periosteal Elevator	23
Whiteside Scaler	68
Wieder Tongue Depressor	35
Wire Bending Pliers	87
Wire Cutters	90
Wire Cutting Scissors	44
Wire Twisters	91
Witzel Root Forceps	14
Woodson Plastic Filling Instruments	75
Wynman Crown Gripper	78

<b>Y</b>	
Yankauer Suction Tubes	98
Young Tongue Seizing Forceps	35
Younger Scaler	68



**DENTAL  
INSTRUMENTS**



**AWARD**  
**INDUSTRIES**

Address:

Small Industrial Estate, Shahabpura,  
Uggoki Road, PO Box 3007,  
Sialkot-Pakistan.

Tel: + 92-52-3252586-3240085-3240086

Fax: + 92-52-3561975

Email: [info@awardind.com](mailto:info@awardind.com)

Email: [award@skt.comsats.net.pk](mailto:award@skt.comsats.net.pk)

[www.awardind.com](http://www.awardind.com)